



K-LITE

Demountable
Partitioning
Systems

Innovation for **total VISION™**

NY Glazing continues with the concept of 'Total Vision' to create transparent & elegant commercial spaces. Every fitting in our Architectural Glass Hardware range is designed to meet the concept of 'Total Vision.'

NY Glazing is a young, dynamic company offering Architectural Hardware & Security Solutions through a wide range of standard and customized products. A solution-centric approach has enabled NY Glazing to grow from a startup to one of the leading brands in the Architectural Hardware Industry. Globally the Company has made its footprint by supplying goods to almost 40+ countries. With a Global Perspective in mind right from its inception, the Company has ensured each product has the quality and certifications so that they can be offered to all work markets.

Manufacturing Capability

Our state-of-the-art Manufacturing Facilities backed by design capability enable us to provide other OEM services in the NYC and Overseas. We can offer Stainless Steel OEM services for manufacturing of Casted, Machine Turning, & Sheet Metal Components in all grades of Stainless Steel and other metals.



AUTOMATED STATE-OF-THE-ART Manufacturing Facility

Our manufacturing units are equipped with the latest CNC Machines, Hi-Tech Laser Machines, Water Jet Cutting Machines, and Automatic Polishing and Robotic Welding Machines to deliver consistent finishes. All units have unique operations that work together continuously at maximum efficiency. Each product is checked for quality and perfection, ensuring the highest level of customer satisfaction.



CNC Laser Cutting Machine



VMC (Vertical Machine Centre)

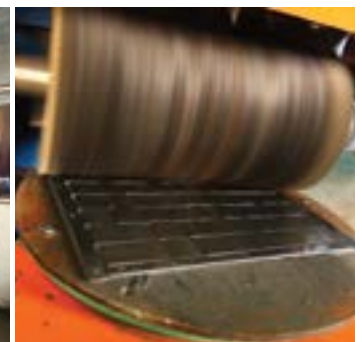

Polishing Machine



CNC Punching Machine

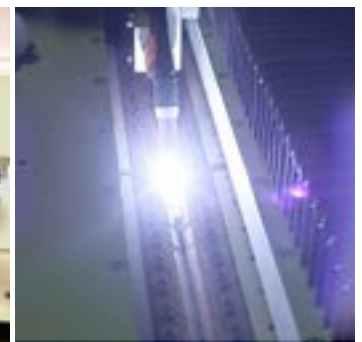

Welding Centre

For over two decades, NY Glazing has offered Architectural Hardware Solutions with a diversified portfolio of more than 5000 products. These products are tested and certified internationally for quality, functionality, and performance.

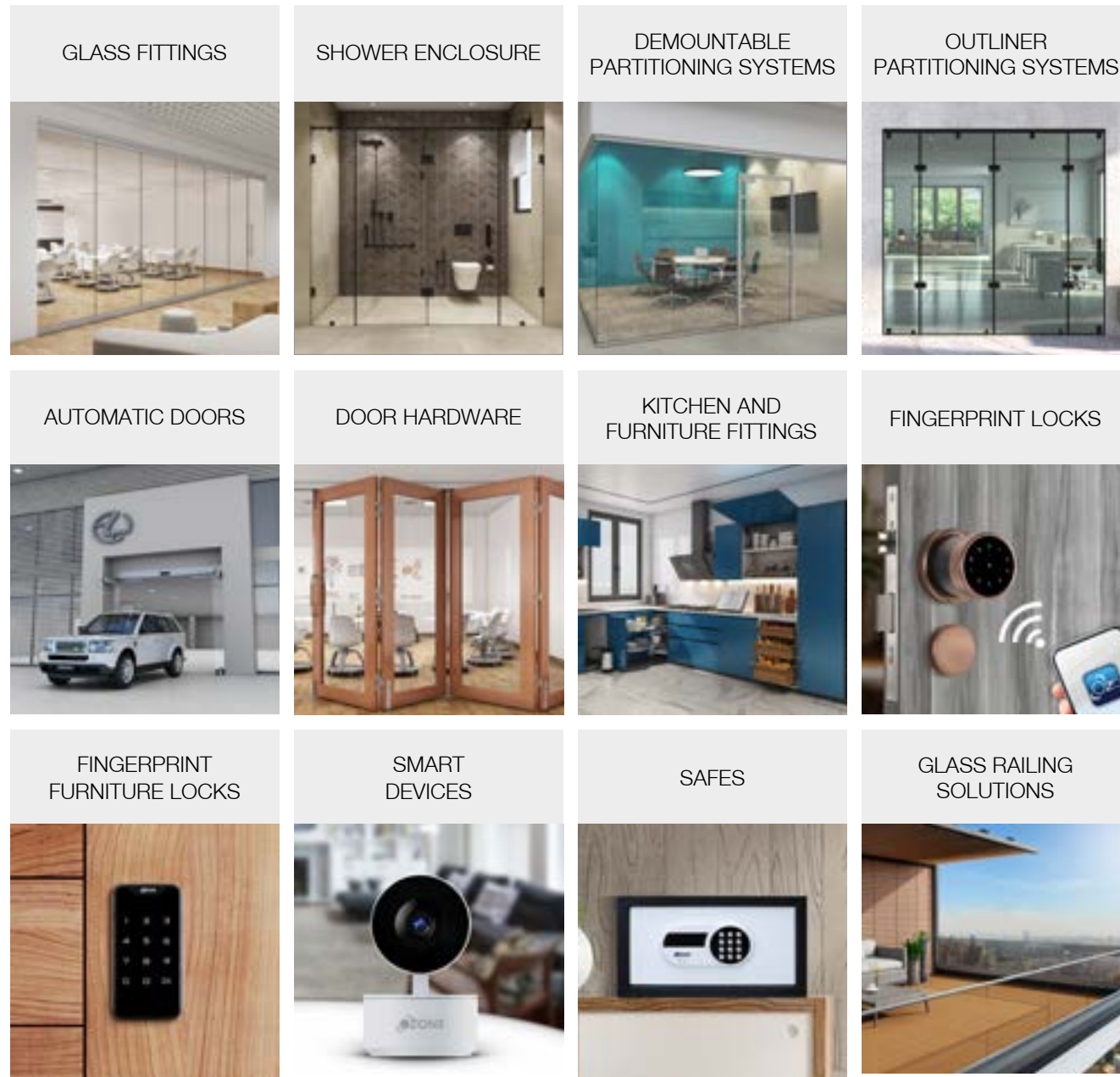

NY Glazing has partnered with **KUBIK** to create New York's most extensive range of Complete Partitioning Solutions for Homes, Offices, Banquets, Schools, and similar establishments.

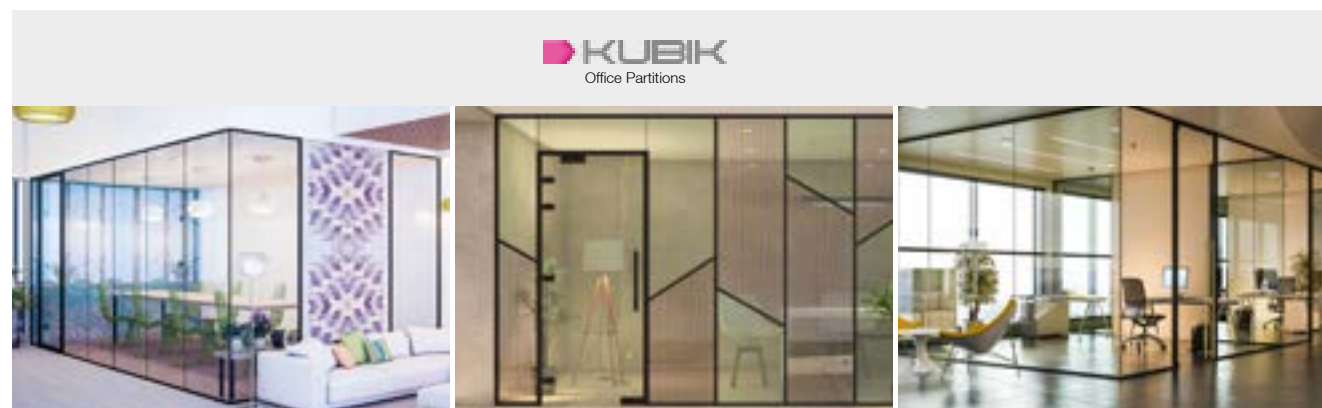

CONTENT

**K-LITE
SERIES**

• K-LITE 25 25mm x 22mm	-	03
K-LITE 25 Door Configuration	-	09
• K-LITE 45 45mm x 22mm	-	21
K-LITE 45 Door Configuration	-	27
• K-LITE 100 100mm x 22mm	-	39
K-LITE 100 Door Configuration	-	45
• K-LITE EF 75 SG 75mm x 30mm	-	57
• K-LITE EF 75 DG 75mm x 30mm	-	61
• K-LITE EF 75 WD 75mm x 30mm	-	65
K-LITE EF 75 Door Configuration	-	68
• SD 60	-	85
• SD 75	-	87
• SLIDING	-	89
• GLASS DOOR	-	91
• ACCESS CONTROL	-	92
• HARDWARE	-	94



How can we solve?

Acoustics: Absorb, Block or Cover

There are three methods of dealing with sound, commonly referred to as the ABC's. Sound can be Absorbed, it can be Blocked or redirected and it can be Covered. The method chosen depends on the final goal of the project.

Sound should be absorbed when the goal is to keep it within the room from reverberating or echoing. If a room has hard surfaces that reflect sound, it will take a long time for the sound level to diminish to a point that it is inaudible. This is most noticeable in an empty room with hard walls, floors and ceilings. You can hear the sounds bouncing around the room. Installing sound absorbing materials such as carpet, acoustic ceiling tiles or fabric covered panels, will reduce the reverberation by absorbing the sound.

Noise Reduction Coefficient, which is defined above, is used for rating a material's ability to absorb sound.

If the goal is to keep the sound within a space, for privacy or other reasons, the sound should be blocked. This can be combined with absorption so that the reverberation in the space is reduced. Blocking sound is generally accomplished by reducing short circuits between two spaces. Common air space is the FIRST path that sound uses and hence this needs to be explored first. If you have a 5% air gap in any kind of a noise barrier, 90% of sound leaks through that air space. Some common features include HVAC ducts or grilles, back-to-back outlets, pipes that pass through a space, partitions that stop above the ceiling but do not extend to the structural deck above. Adding mass to the walls will help block the sound. For instance, a concrete wall blocks sound better than a stud wall. Additional layers of gypsum wall board and insulation in the wall cavity will also help block the sound.

Sound can also be covered to help maintain speech privacy. This is most noticeable in an office environment when the forced air system is turned off. The idea is to provide just a bit of background noise to make nearby conversations unintelligible; the conversation is still there, but the quiet hum of the noise (soft music) masks it.

Acoustic Partition Specification

Why is it required?

An office is the centre of communication, thinking & collaboration. Any unwanted noise within an office is a major distraction and is a reason for employees not being able to achieve optimum productivity. Soundproofing is a necessity for offices, because apart from the noise within office interiors, there is a huge problem of unwanted noise from the exteriors such as traffic, construction, etc. which have the same unpleasant effect. The soundproof offices help in noise cancellation of this unwanted noise which intrudes the 'Thinking Space' of the employees.

Similarly, besides noise reduction, at times it is required to prevent certain discussions from being heard outside a cabin or conference room. Our state-of-the-art Acoustic Office Demountable Glass Partitions makes sure that peace and tranquillity within the office is maintained, and that important discussions remain confidential.

Leakage of sounds come from three common places;

a - Common air space (Ceiling), b - Mass & Density (Walls), c - Hard surface (Floor)

Poor Acoustic

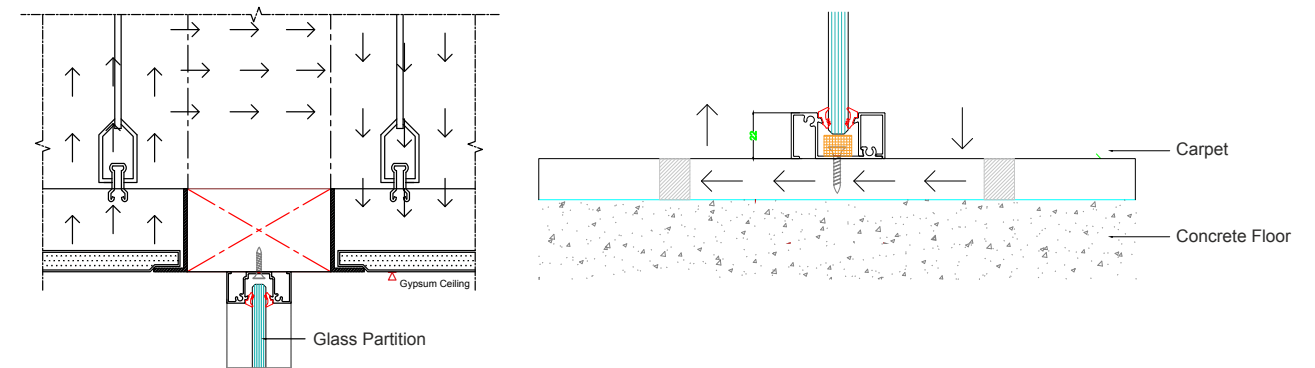

Good Acoustic

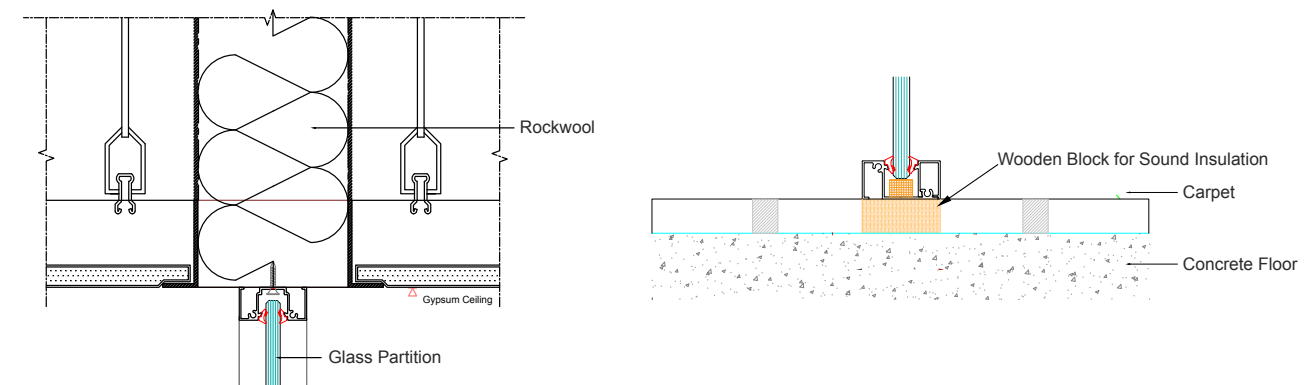

K-LITE 25

25mm x 22mm (single glaze)



CONTEMPORARY WORKING SPACES WITH MINIMALISTIC APPROACH

K-LITE 25 series Demountable Architectural Office Partitions can be equipped with strong acoustic insulation, for more relaxing atmosphere within the large office spaces, with minimal section visibility. Multiple options of solid door or tempered glass can be created, which can be installed along with the selection of door frames.

K-LITE 25

25mm x 22mm (single glaze)



K-LITE 25

25mm x 22mm (single glaze)

Technical Details

CONTEMPORARY WORKING SPACE WITH MINIMALISTIC APPROACH

K-LITE 25 Series Demountable Architectural Office Partitions can be equipped with strong acoustic insulation, for more relaxing atmosphere within the large office spaces, with minimal section visibility. Multiple options of solid door or tempered glass can be created, which can be installed along with the selection of door frames.

Features

- Standard Section : 25mm x 22mm
- Slim in design, the standard partition suite can be used with any stud thickness
- Suitable for 8mm / 10mm / 12mm toughened glass
- Single door frame sizes to allow for flush door 35mm
- Partition height can be offered up to 3000mm
- Single glazed systems
- Sound insulation capacity of 30 - 32 dB

Door options

- Frame less glass, Stile glaze door, Timber or Sliding door system

Solid doors

- Timber doors can be of 44mm solid core in choice of veneers*

Door frames

- Aluminium full height up to 3000mm, doors are mounted on either of the hinges, pivots or sliding tracks. A range of Ironmongery can be supplied and incorporated with K-LITE 25 series

Size limits

- K-LITE is designed for installation in areas up to nominal vertical panel size of 3000mm x 1200mm

Finish

- All exposed aluminium sections are Silver Anodized aluminium finish with 6063 T6 Grade

Assembly Characteristics

Glazed panels are hung onto a site installed framework of recessed head, side walls and base channels, studs and transoms.

Base tracks have a snap in profile for better installation of glass into section using beads made of silicone gel material and choice of junctions available. Assembly jig supplied ensures the speed accuracy of the installation and correct alignments of panel.

All panels can be removed independently of each other allowing replacement or variation at any time after initial installation.

Available in two colors

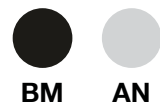

* Kindly consult with our team before placing order or confirmation

K-LITE 25

25mm x 22mm (single glaze)

Technical Details

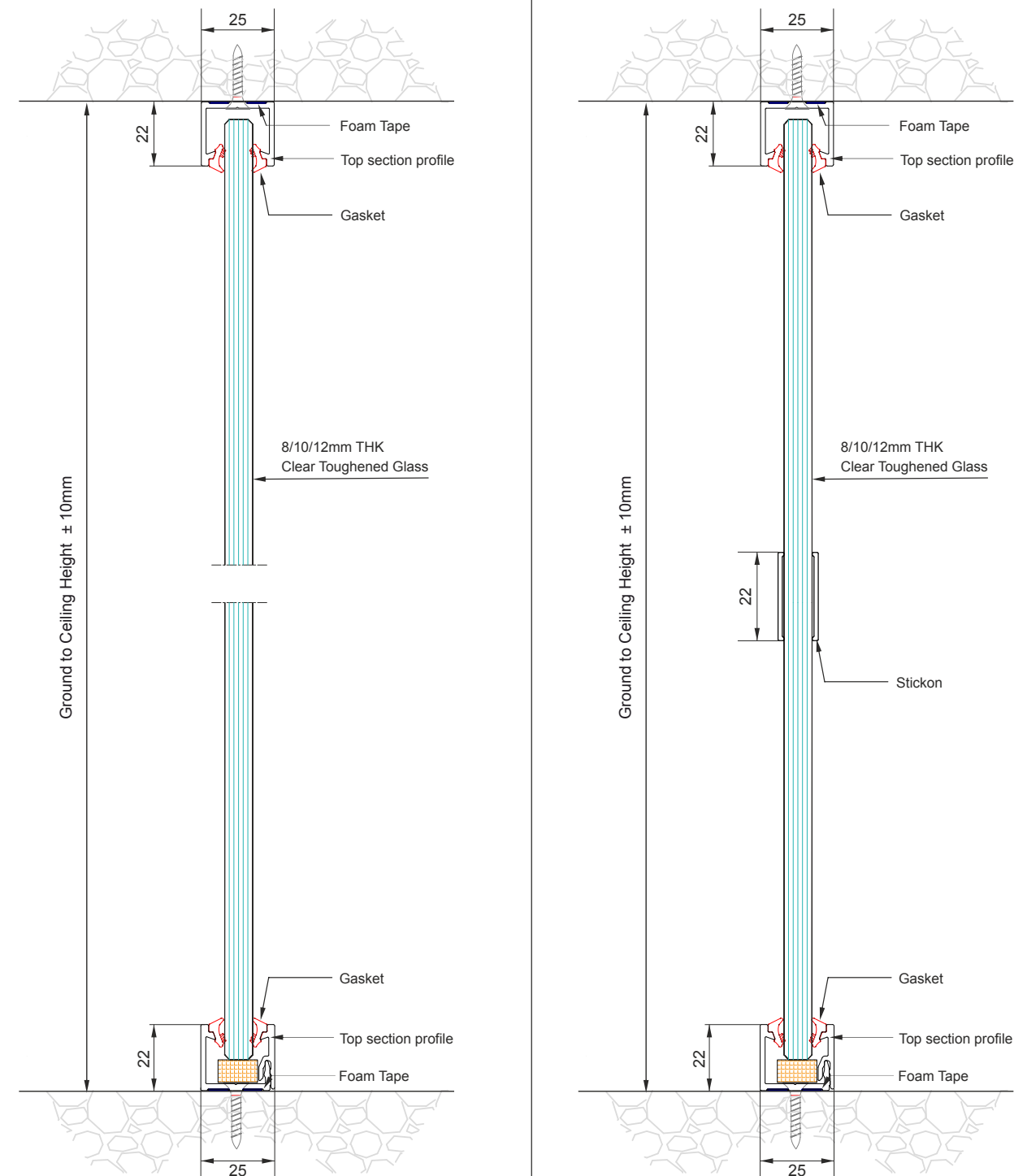

K-LITE 25

25mm x 22mm (single glaze)

SOPHISTICATED ARCHITECTURAL DESIGN OPTIONS

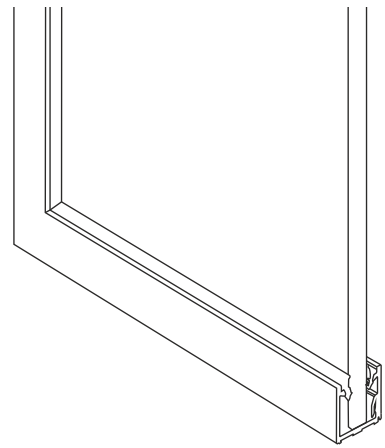

Single Glazed Partition - 25mm x 22mm

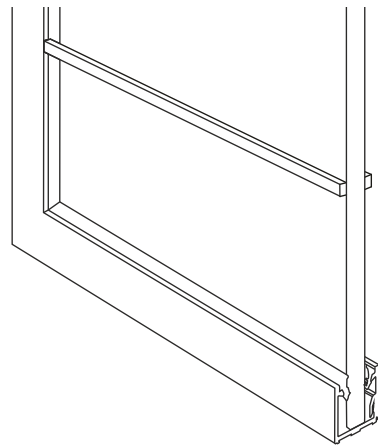

Single Glazed Partition with stickon - 25mm x 22mm

THESE ARE THE OPTIONS FOR JOINING GLASS AT I, L & T JUNCTIONS

Suitable for 8mm / 10mm / 12mm toughened glass.

The profiles feature a double-sided adhesive tape that guarantee a perfect structural union and sound insulation.

I JOINT

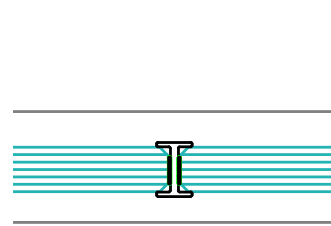

L JOINT

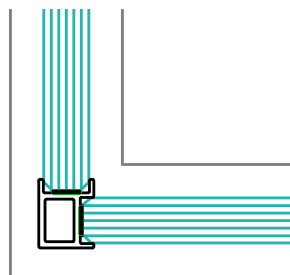

T JOINT

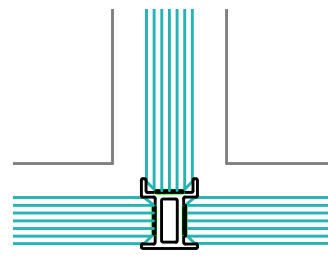

K-LITE 25

25mm x 22mm (single glaze)



K-LITE 25

25mm x 22mm (single glaze)

Door Configuration



K-LITE 25 Glazing
with I Joint and
K-LITE 45 Door
Frame.

Door :- Stile 60
on Hinges with
Mortise lock
and handle

K-LITE 25 Glazing
with Stickon and
K-LITE 45 Door
Frame.

Door :- Stile 60
on Hinges with
Stickon and
Mortise lock
and handle



K-LITE 25

25mm x 22mm (single glaze)

Door Configuration



K-LITE 25 Glazing
with I Joint and
K-LITE 45 Door
Frame.

Door :- Glass Door
with side hinges, D
handle, bottom lock
and Door Closer.

K-LITE 25 Glazing
with I Joint and
K-LITE 45 Door
Frame.

Door :- Glass Door
with Top-bottom
Pivot, D handle and
bottom lock



K-LITE 25 Glazing
with I Joint and
K-LITE 45 Door
Frame.

Door :- Glass Door
with Top-bottom
Pivot, H handle
and bottom lock

K-LITE 25 Glazing
with I Joint and
K-LITE 45 Door
Frame.

Door :- Glass Door
with side hinges,
Studio Lock and
Door Closer.



K-LITE 25 Glazing
with I Joint and
K-LITE 45 Door
Frame.

Door :- Glass Door
with Top-bottom
Pivot, Double D
handle and bottom
lock

K-LITE 25 Glazing
with I Joint and
K-LITE 45 Door
Frame.

Door :- Glass Door
with side hinges, H
handle, bottom lock
and Door Closer.



K-LITE 25

25mm x 22mm (single glaze)

Door Configuration



K-LITE 25 Glazing
with Stickon and
Ultra45 Door Frame.

Door :- Wooden
Door with hinges,
H handle and Door
Closer.



K-LITE 25 Glazing
with I Joint and
Ultra45 Door Frame.

Door :- Wooden
Door with hinges,
H handle and Door
Closer.



K-LITE 25 Glazing
with I Joint and
Ultra45 Door Frame.

Door :- Glass Door
with Top-bottom
Pivot and Studio
lock



K-LITE 25

25mm x 22mm (single glaze)



K-LITE 25

25mm x 22mm (single glaze)

Door Configuration

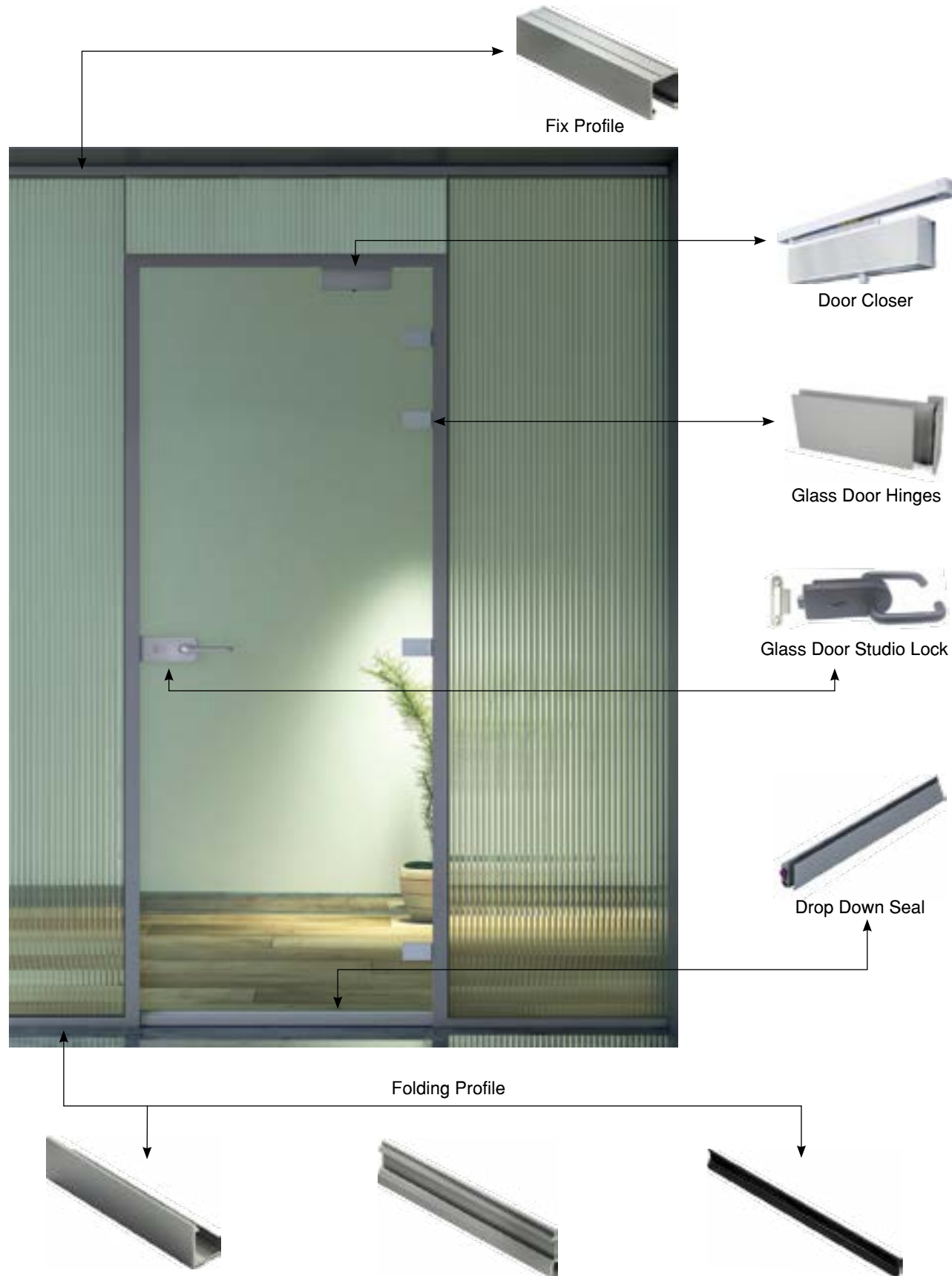

K-LITE 25

25mm x 22mm (single glaze)

Typical Layout

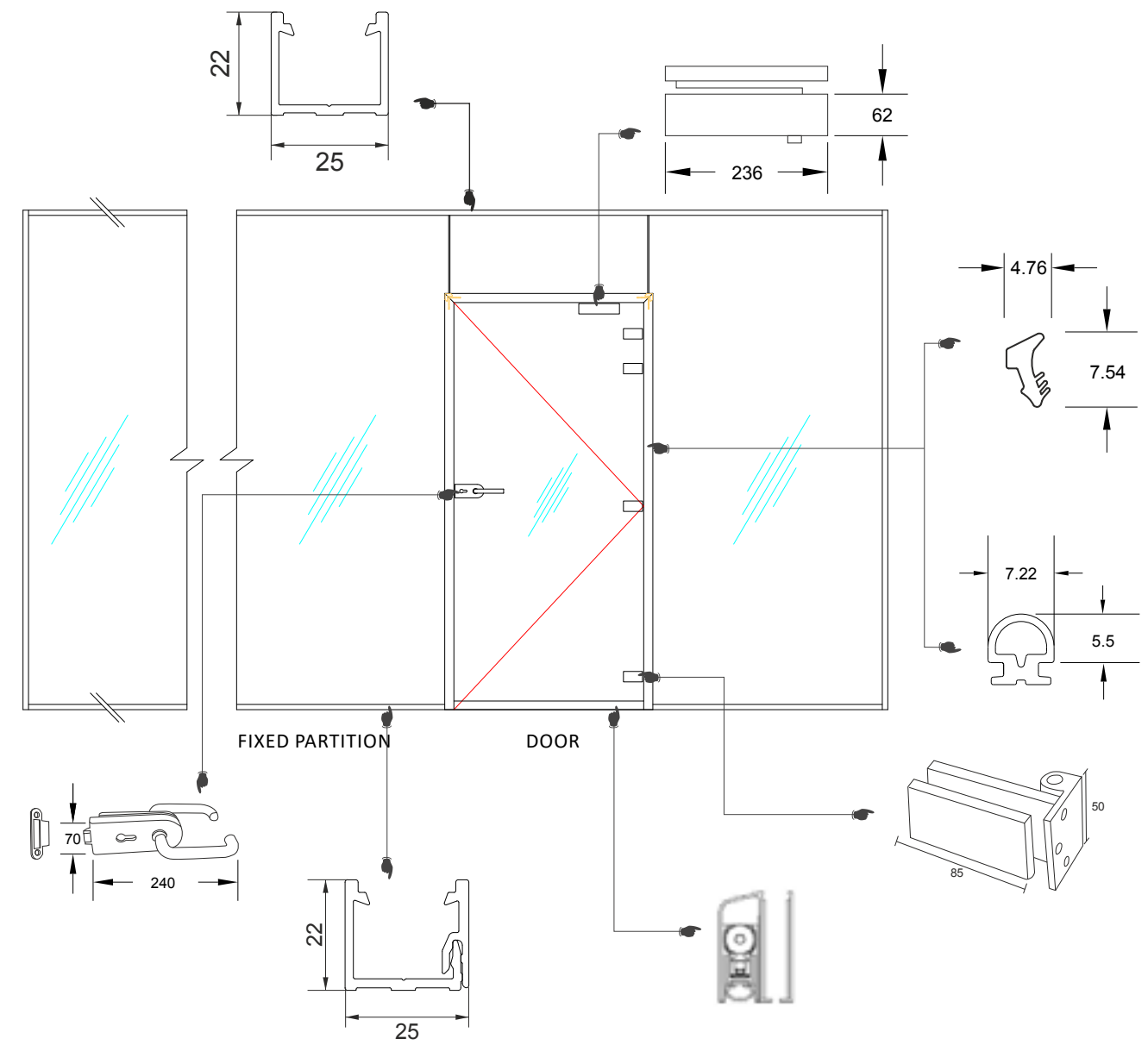

K-LITE 25

25mm x 22mm

K-LITE 25 (25mmx22mm)

IMAGES	CODE	DESCRIPTION	UNIT	SIZE	COLOUR
	OZKL-25-001 3M AN OZKL-25-001 3M BM	K-LITE 25mm x 22mm Fix Profile	SET	3 Mtr.	● Silver Anodized ● Black Matt
	OZKL-25-002 3M AN OZKL-25-002 3M BM	K-LITE 25mm x 22mm Folding Profile	Pcs.	3 Mtr.	● Silver Anodized ● Black Matt
	OZKLST-001 3M AN OZKLST-001 3M BM	Stickon Profile	Pcs.	3 Mtr.	● Silver Anodized ● Black Matt
	OZKL-45-001 2.5M AN OZKL-45-001 2.5M BM OZKL-45-001 3M AN OZKL-45-001 3M BM	K-LITE 45mm x 22mm Fix Profile	Pcs.	2.5 Mtr. 2.5 Mtr. 3 Mtr. 3 Mtr.	● Silver Anodized ● Black Matt ● Silver Anodized ● Black Matt
	OZKL-45-003 3M AN OZKL-45-003 3M BM	Flush Cap for Floor Machine Use	Pcs.	3 Mtr.	● Silver Anodized ● Black Matt
	OZKL-PT-001 2.5M AN OZKL-PT-001 2.5M BM OZKL-PT-001 3M AN OZKL-PT-001 3M BM	Door Jamb for SD 60 and 35mm Solid Door	Pcs.	2.5 Mtr. 2.5 Mtr. 3 Mtr. 3 Mtr.	● Silver Anodized ● Black Matt ● Silver Anodized ● Black Matt
	OZKL-D60-101 2.5M AN OZKL-D60-101 2.5M BM OZKL-D60-101 3M AN OZKL-D60-101 3M BM	SD 60 Vertical Profile 60 x 35	Pcs.	2.5 Mtr. 2.5 Mtr. 3 Mtr. 3 Mtr.	● Silver Anodized ● Black Matt ● Silver Anodized ● Black Matt
	OZKL-D60-102 2.1M AN OZKL-D60-102 2.1M BM	SD 60 Top-Bottom Profile 60 x 35	Pcs.	3 Mtr.	● Silver Anodized ● Black Matt

● Gold Matt ● Champagne Matt ● Rose Gold Matt
*Finishes Available on Request

K-LITE 25

25mm x 22mm

K-LITE 25 (25mmx22mm)

IMAGES	CODE	DESCRIPTION	UNIT	SIZE	COLOUR
	OZKL-I-08 3M AN OZKL-I-08 3M BM	I Joint for 8mm glass	Pcs.	3 Mtr.	● Silver Anodized ● Black Matt
	OZKL-I-10 3M AN OZKL-I-10 3M BM	I Joint for 10mm glass	Pcs.	3 Mtr.	● Silver Anodized ● Black Matt
	OZKL-I-12 3M AN OZKL-I-12 3M BM	I Joint for 12mm glass	Pcs.	3 Mtr.	● Silver Anodized ● Black Matt
	OZKL-L-08 3M AN OZKL-L-08 3M BM	L Joint for 8mm glass	Pcs.	3 Mtr.	● Silver Anodized ● Black Matt
	OZKL-L-10 3M AN OZKL-L-10 3M BM	L Joint for 10mm glass	Pcs.	3 Mtr.	● Silver Anodized ● Black Matt
	OZKL-L-12 3M AN OZKL-L-12 3M BM	L Joint for 12mm glass	Pcs.	3 Mtr.	● Silver Anodized ● Black Matt
	OZKL-T-08 3M AN OZKL-T-08 3M BM	T Joint for 8mm glass	Pcs.	3 Mtr.	● Silver Anodized ● Black Matt
	OZKL-T-10 3M AN OZKL-T-10 3M BM	T Joint for 10mm glass	Pcs.	3 Mtr.	● Silver Anodized ● Black Matt

● Gold Matt ● Champagne Matt ● Rose Gold Matt
*Finishes Available on Request

K-LITE 25

25mm x 22mm

K-LITE 25 (25mmx22mm)



IMAGES	CODE	DESCRIPTION	UNIT	SIZE	COLOUR
	OZKL-T-12 3M AN OZKL-T-12 3M BM	T Joint for 12mm glass	Pcs.	3 Mtr.	● Silver Anodized ● Black Matt
	OZKL-GASKET-001 GR OZKL-GASKET-001 BK	Used for Door Frame Profile	RMTR	1 Mtr.	● Grey ● Black
	OZKL-GASKET-002-08 GR OZKL-GASKET-002-08 BK	Gasket for 8mm glass	RMTR	1 Mtr.	● Grey ● Black
	OZKL-GASKET-004-10 GR OZKL-GASKET-004-10 BK	Gasket for 10mm glass	RMTR	1 Mtr.	● Grey ● Black
	OZKL-GASKET-003-12 GR OZKL-GASKET-003-12 BK	Gasket for 12mm glass	RMTR	1 Mtr.	● Grey ● Black
	OZKL-GASKET-005 GR OZKL-GASKET-005 BK	Gasket for Door Jamb	RMTR	1 Mtr.	● Grey ● Black
	OZKL-ACC-001	Corner Connector for Door Jamb	Pcs.	1	
	OZKL-ACC-002	Corner Connector for Glazing Profile	Pcs.	1	

● Gold Matt ● Champagne Matt ● Rose Gold Matt
*Finishes Available on Request

K-LITE 25

25mm x 22mm

K-LITE 25 (25mmx22mm)

IMAGES	CODE	DESCRIPTION	UNIT	SIZE	COLOUR
	OZKL-ACC-003	Threaded Rod for Door 1mtr	SET		
	OZKL-ACC-004	Threaded Rod for Door 2mtr	SET		
	OZKLFT 10MMx1MMx10M	Acoustical Single Side Foam Tape	Roll		
	OZKLCT 6MMx1MMx10M	Double Sided Acrylic Clear Tape used for I, L, T Joint	Roll		
	OZKLCT 18MMx0.8MMx10M	Double Sided Acrylic Clear Tape used for BrooOZKLyn Profile	Roll		
	OZKL-25-EC BM	End Cap	Pcs.	1	

● Gold Matt ● Champagne Matt ● Rose Gold Matt
*Finishes Available on Request

K-LITE 45

45mm x 22mm (single glaze)



RELAXING ATMOSPHERE OFFICE SPACE

The K-LITE 45 Demountable Architectural Office Partition is a superior lightweight profile system. It is based on a 45mm x 22mm glazing seal and bead with a selection of door frame options. K-LITE 45 frames provide elegant and cost effective design solutions.

K-LITE 45

45mm x 22mm (single glaze)

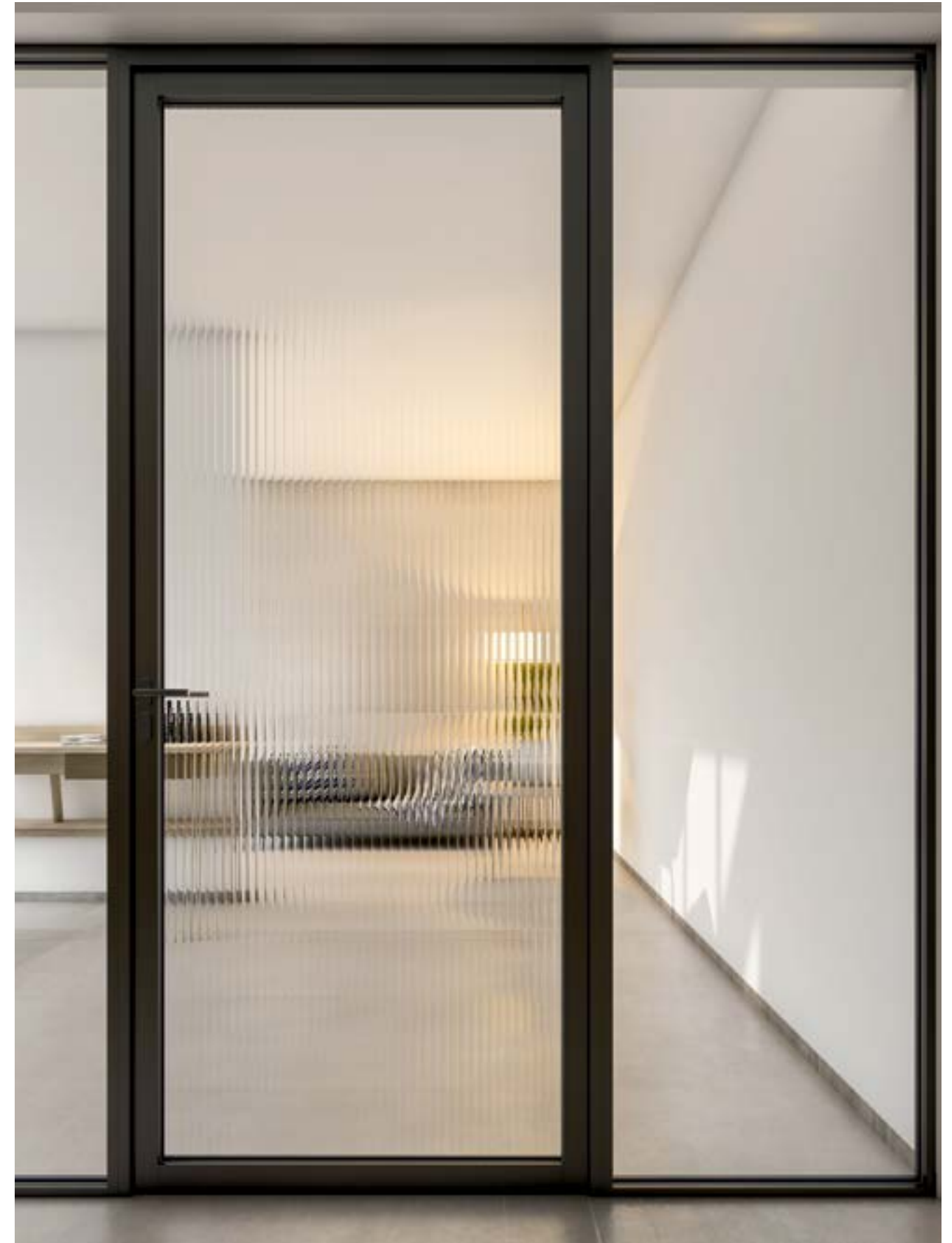

K-LITE 45

45mm x 22mm (single glaze)

Technical Details

CONTEMPORARY WORKING SPACE WITH MINIMALISTIC APPROACH

The K-LITE 45 Demountable Architectural Office Partition is a superior lightweight profile system. It is based on a 45mm x 22mm glazing seal and bead with a selection of door frame option. K-LITE 45 frames provide an elegant and cost effective design solutions.

Features

- Standard section : 45mm x 22mm
- Slim in design, the standard partition suite can be used with any stud thickness
- Suitable for 8mm / 10mm / 12mm toughened glass
- Single door frame sizes to allow for flush door 35mm
- Partition height can be offered up to 3000mm
- Single glazed systems
- Sound insulation capacity of 32 - 34 dB

Door options

- Frame less glass, Stile glaze door, Timber or Sliding door system

Soild doors

- Timber doors can be of 35mm or 45mm solid core in choice of veneers*

Door frames

- Aluminium full height up to 3000mm, doors are mounted on either of the hinges, pivots or sliding tracks. A range of Ironmongery can be supplied and incorporated with K-LITE 25 series.

Size limits

- K-LITE is designed for installation in areas up to nominal vertical panel size of 3000mm x 1200mm

Finish

- All exposed aluminium sections are Silver Anodized aluminium finish with 6063 T6 Grade

Assembly Characteristics

Glazed panels are hung onto a site installed framework of recessed head, side walls and base channels, studs and transoms.

Base tracks have a snap in profile for better installation of glass into section using beads made of silicone gel material and choice of junctions available. Assembly jig supplied ensures the speed accuracy of the installation and correct alignments of panel.

All panels can be removed independently of each other allowing replacement or variation at any time after initial installation.

Available in two colors



* Kindly consult with our team before placing order or confirmation

K-LITE 45

45mm x 22mm (single glaze)

Technical Details

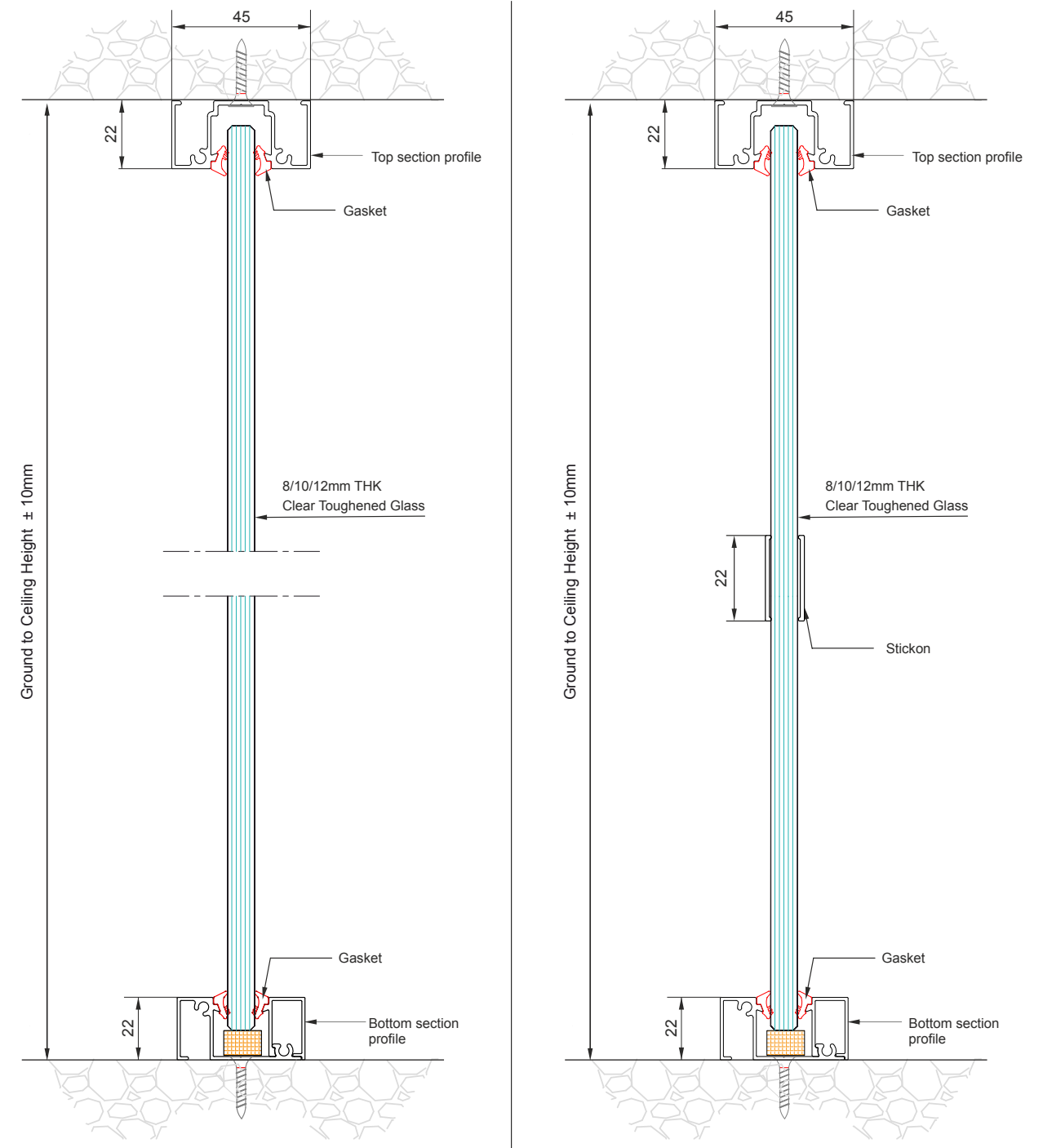

K-LITE 45

45mm x 22mm (single glaze)

SOPHISTICATED ARCHITECTURAL DESIGN OPTIONS

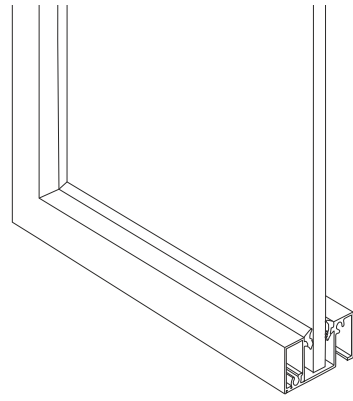

Single Glazed Partition - 45mm x 22mm

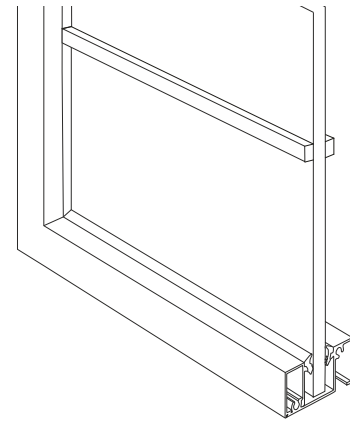

Single Glazed Partition with stickon - 45mm x 22mm

THESE ARE THE OPTIONS FOR JOINING GLASS AT I, L & T JUNCTIONS

Suitable for 8mm / 10mm / 12mm toughened glass.

The profiles feature a double-sided adhesive tape that guarantee a perfect structural union and sound insulation.

I JOINT

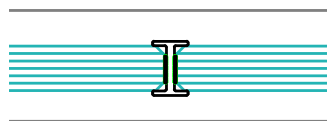

L JOINT

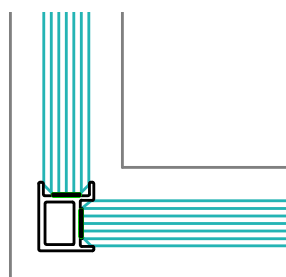

T JOINT

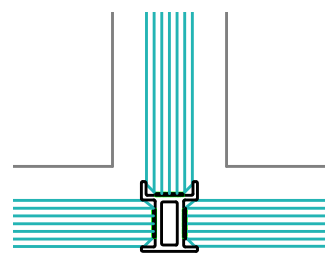

K-LITE 45

45mm x 22mm (single glaze)



K-LITE 45

45mm x 22mm (single glaze)

Door Configuration



K-LITE 45 Glazing with I Joint and K-LITE 45 Door Frame.

Door :- Glass Door with Top-bottom Pivot, D handle and bottom lock



K-LITE 45 Glazing with I Joint and K-LITE 45 Door Frame.

Door :- Glass Door with side hinges, H handle, bottom lock and Door Closer.



K-LITE 45 Glazing with Stickon and K-LITE 45 Door Frame.

Door :- Stile 60 on Hinges with Stickon and Mortise lock and handle



K-LITE 45 Glazing with I joint and K-LITE 45 Door Frame.

Door :- Stile 60 on Hinges with Mortise lock and handle

K-LITE 45

45mm x 22mm (single glaze)

Door Configuration



K-LITE 45 Glazing with Stickon and K-LITE 45 Door Frame.

Door :- Wooden Door with hinges, H handle and Door Closer.



K-LITE 45 Glazing with I Joint and K-LITE 45 Door Frame.

Door :- Wooden Door with hinges, H handle and Door Closer.

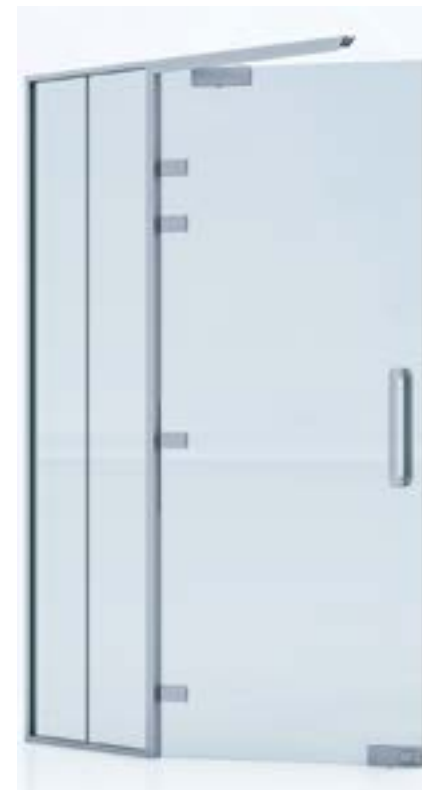

K-LITE 45 Glazing with I Joint and K-LITE 45 Door Frame.

Door :- Glass Door with side hinges, Door closer and Studio Lock.



K-LITE 45 Glazing with I Joint and K-LITE 45 Door Frame.

Door :- Glass Door with side hinges, D handle, bottom lock and Door Closer.

K-LITE 45

45mm x 22mm (single glaze)

Door Configuration



K-LITE 45 Glazing
with Stickon and
K-LITE 45 Door
Frame.

Door :- Stile 75 with
Stickon and Mortise
lock and handle

K-LITE 45 Glazing
with I joint and
K-LITE 45 door
frame.

Door :- Stile 75
with Mortise lock
and handle



K-LITE 45

45mm x 22mm (single glaze)

Door Configuration



K-LITE 45 Glazing
with I Joint and
K-LITE 45 Door
Frame.

Door :- Glass Door
with Top-bottom
Pivot, H handle and
Bottom lock

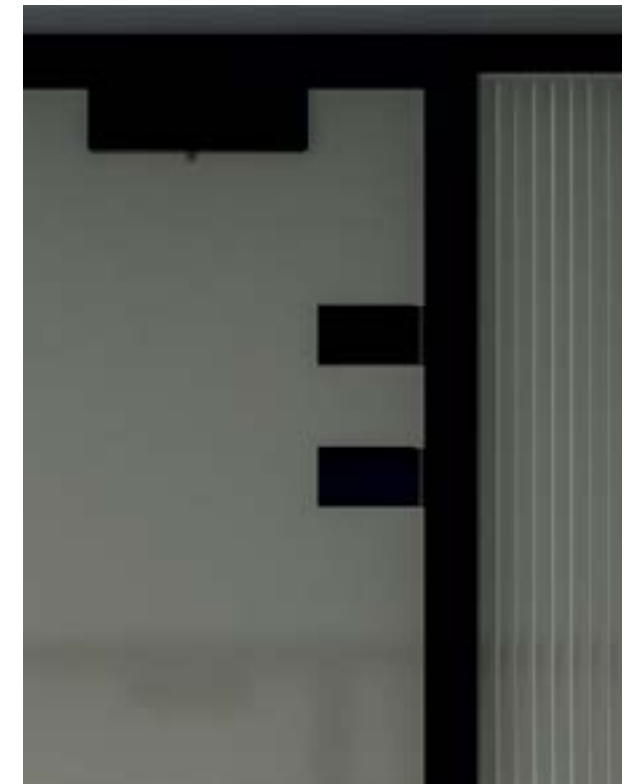

K-LITE 45 Glazing
with I joint and
K-LITE 45 door
frame.

Door :- Glass Door
with side hinges,
Double D handle,
bottom lock and
Door Closer.

K-LITE 45 Glazing
with I Joint and
K-LITE 45 Door
Frame.

Door :- Glass Door
with Top-bottom
Pivot and Studio
lock

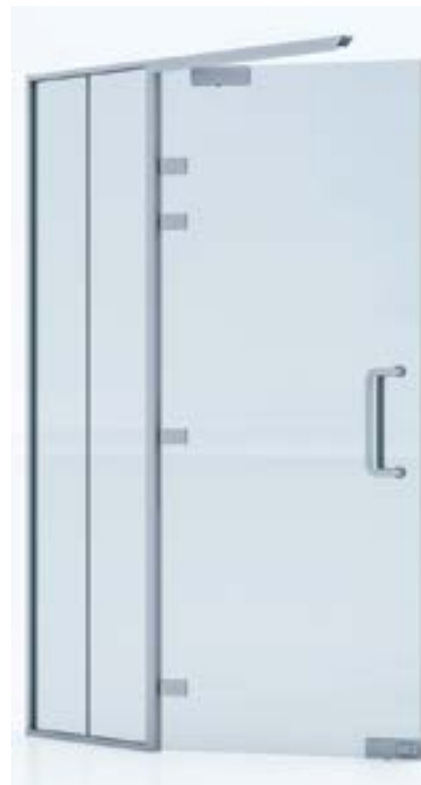

K-LITE 45

45mm x 22mm (single glaze)

Door Configuration



K-LITE 45

45mm x 22mm (single glaze)

Typical Layout

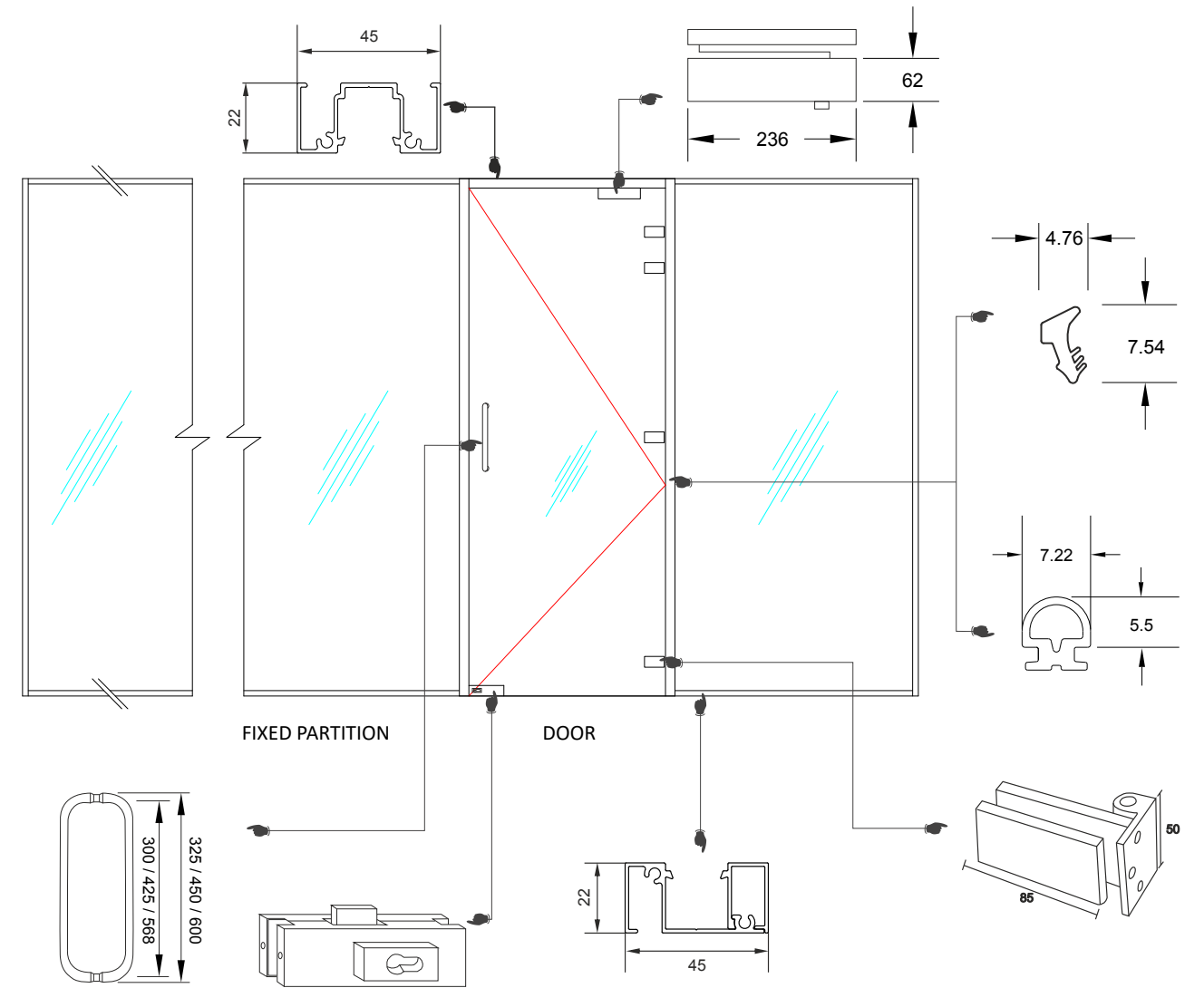

K-LITE 45

45mm x 22mm

K-LITE 45 (45mmx22mm)

IMAGES	CODE	DESCRIPTION	UNIT	SIZE	COLOUR
	OZKL-45-001 2.5M AN OZKL-45-001 2.5M BM OZKL-45-001 3M AN OZKL-45-001 3M BM	K-LITE 45mm x 22mm Fix Profile	SET	2.5 Mtr. 2.5 Mtr. 3 Mtr. 3 Mtr.	● Silver Anodized ● Black Matt ● Silver Anodized ● Black Matt
	OZKL-45-002 3M AN OZKL-45-002 3M BM	K-LITE 45mm x 22mm Folding Profile	Pcs.	3 Mtr.	● Silver Anodized ● Black Matt
	OZKL-45-003 3M AN OZKL-45-003 3M BM	Flush Cap for Floor Machine Use	Pcs.	3 Mtr.	● Silver Anodized ● Black Matt
	OZKL-45-004 3M AN OZKL-45-004 3M BM	Brooklyn 45mm x 25mm Clip Profile	Pcs.	2.5 Mtr. 2.5 Mtr. 3 Mtr. 3 Mtr.	● Silver Anodized ● Black Matt ● Silver Anodized ● Black Matt
	OZKL-45-005 3M AN OZKL-45-005 3M BM	Brooklyn 45mm x 25mm Base Profile	Pcs.	3 Mtr.	● Silver Anodized ● Black Matt
	OZKLST-001 3M AN OZKLST-001 3M BM	Stickon Profile	Pcs.	3 Mtr.	● Silver Anodized ● Black Matt
	OZKL-PT-001 2.5M AN OZKL-PT-001 2.5M BM OZKL-PT-001 3M AN OZKL-PT-001 3M BM	Door Jamb for SD 60 and 35mm Solid Door	Pcs.	2.5 Mtr. 2.5 Mtr. 3 Mtr. 3 Mtr.	● Silver Anodized ● Black Matt ● Silver Anodized ● Black Matt
	OZKL-PT-002 2.5M AN OZKL-PT-002 2.5M BM OZKL-PT-002 3M AN OZKL-PT-002 3M BM	Door Jamb for SD 75 and 45mm Solid Door	Pcs.	2.5 Mtr. 2.5 Mtr. 3 Mtr. 3 Mtr.	● Silver Anodized ● Black Matt ● Silver Anodized ● Black Matt
	OZKL-D60-101 2.5M AN OZKL-D60-101 2.5M BM OZKL-D60-101 3M AN OZKL-D60-101 3M BM	SD 60 Vertical Profile 60 x 35	Pcs.	2.5 Mtr. 2.5 Mtr. 3 Mtr. 3 Mtr.	● Silver Anodized ● Black Matt ● Silver Anodized ● Black Matt
	OZKL-D60-102 2.1M AN OZKL-D60-102 2.1M BM	SD 60 Top-Bottom Profile 60 x 35	Pcs.	2.1 Mtr.	● Silver Anodized ● Black Matt

● Gold Matt ● Champagne Matt ● Rose Gold Matt
*Finishes Available on Request

K-LITE 45

45mm x 22mm

K-LITE 45 (45mmx22mm)

IMAGES	CODE	DESCRIPTION	UNIT	SIZE	COLOUR
	OZKL-D75-103 2.5M AN OZKL-D75-103 2.5M BM OZKL-D75-103 3M AN OZKL-D75-103 3M BM	SD 75 Vertical Profile 75 x 45	Pcs.	2.5 Mtr. 2.5 Mtr. 3 Mtr. 3 Mtr.	● Silver Anodized ● Black Matt ● Silver Anodized ● Black Matt
	OZKL-D75-104 2.1M AN OZKL-D75-104 2.1M BM	SD 75 Top-Bottom Profile 75 x 45	Pcs.	2.1 Mtr.	● Silver Anodized ● Black Matt
	OZKL-I-08 3M AN OZKL-I-08 3M BM	I Joint for 8mm glass	Pcs.	3 Mtr.	● Silver Anodized ● Black Matt
	OZKL-I-10 3M AN OZKL-I-10 3M BM	I Joint for 10mm glass	Pcs.	3 Mtr.	● Silver Anodized ● Black Matt
	OZKL-I-12 3M AN OZKL-I-12 3M BM	I Joint for 12mm glass	Pcs.	3 Mtr.	● Silver Anodized ● Black Matt
	OZKL-L-08 3M AN OZKL-L-08 3M BM	L Joint for 8mm glass	Pcs.	3 Mtr.	● Silver Anodized ● Black Matt
	OZKL-L-10 3M AN OZKL-L-10 3M BM	L Joint for 10mm glass	Pcs.	3 Mtr.	● Silver Anodized ● Black Matt
	OZKL-L-12 3M AN OZKL-L-12 3M BM	L Joint for 12mm glass	Pcs.	3 Mtr.	● Silver Anodized ● Black Matt

● Gold Matt ● Champagne Matt ● Rose Gold Matt
*Finishes Available on Request

K-LITE 45

45mm x 22mm

K-LITE 45 (45mmx22mm)









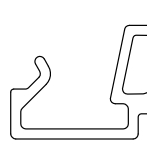

IMAGES	CODE	DESCRIPTION	UNIT	SIZE	COLOUR
	OZKL-T-08 3M AN OZKL-T-08 3M BM	T Joint for 8mm glass	Pcs.	3 Mtr.	● Silver Anodized ● Black Matt
	OZKL-T-10 3M AN OZKL-T-10 3M BM	T Joint for 10mm glass	Pcs.	3 Mtr.	● Silver Anodized ● Black Matt
	OZKL-T-12 3M AN OZKL-T-12 3M BM	T Joint for 12mm glass	Pcs.	3 Mtr.	● Silver Anodized ● Black Matt
	OZKL-GASKET-001 GR OZKL-GASKET-001 BK	Used for Door Frame Profile	RMTR	1 Mtr.	● Grey ● Black
	OZKL-GASKET-002-08 GR OZKL-GASKET-002-08 BK	Gasket for 8mm glass	RMTR	1 Mtr.	● Grey ● Black
	OZKL-GASKET-004-10 GR OZKL-GASKET-004-10 BK	Gasket for 10mm glass	RMTR	1 Mtr.	● Grey ● Black
	OZKL-GASKET-003-12 GR OZKL-GASKET-003-12 BK	Gasket for 12mm glass	RMTR	1 Mtr.	● Grey ● Black
	OZKL-GASKET-005 GR OZKL-GASKET-005 BK	Gasket for Door Jamb	RMTR	1 Mtr.	● Grey ● Black
	OZKL-KOPS013A 3.1M AN OZKL-KOPS013A 3.1M BM	Clip Cover Strip A-for Small Opening-Lengt 3.1 mtr	Pcs.	3.1 Mtr.	● Silver Anodized ● Black Matt
	OZKL-KOPS051 3.1M AN OZKL-KOPS051 3.1M BM	Main Portal 45X45	Pcs.	3.1 Mtr.	● Silver Anodized ● Black Matt

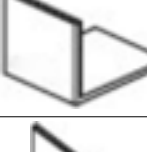
● Gold Matt ● Champagne Matt ● Rose Gold Matt
*Finishes Available on Request

K-LITE 45

45mm x 22mm

K-LITE 45 (45mmx22mm)

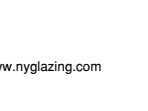
IMAGES	CODE	DESCRIPTION	UNIT	SIZE	COLOUR
	OZKL-KOPS051A 3.1M AN OZKL-KOPS051A 3.1M BM	Clip Profile for holding the Glass with Gasket Length - 3.1 mtr.	Pcs.	3.1 Mtr.	● Silver Anodized ● Black Matt
	OZKL-KOPS003 3.0M AN OZKL-KOPS003 3.0M BM	Clip Cover Strip A-for Big Opening-Lengt 3.1 mtr	Pcs.	3.1 Mtr.	● Silver Anodized ● Black Matt
	OZKL-ACC-001	Corner Connector for Door Jamb	Pcs.	1	
	OZKL-ACC-002	Corner Connector for Glazing Profile	Pcs.	1	
	OZKL-ACC-003	Threaded Rod for Door 1mtr	SET		
	OZKL-ACC-004	Threaded Rod for Door 2mtr	SET		
	OZKL-ACC-005	Corner Joint for SD 75 when using Door Closer	Pcs.		
	OZKLFT 10MMx1MMx10M	Acoustical Single Side Foam Tape	ROLL		
	OZKLCT 6MMx1MMx10M	Double Sided Acrylic Clear Tape used for I, L, T Joint	ROLL		
	OZKLCT 18MMx0.8MMx10M	Double Sided Acrylic Clear Tape used for BrooOZKLyn Profile	ROLL		
	OZKL-45-EC BM	End Cap	Pcs.	1	

● Gold Matt ● Champagne Matt ● Rose Gold Matt
*Finishes Available on Request

K-LITE 100

100mm x 22mm (single glaze)



ELEGANT GLASS PARTITION FOR MAXIMUM TRANSPARENCY

The K-LITE 100 Demountable Architectural Office Partition is another superior range of K-LITE product that has a proven track record. It is based on a 100mm x 22mm glazing seal and bead with selection of door frame options.

K-LITE 100

100mm x 22mm (single glaze)



K-LITE 100

100mm x 22mm (single glaze)

Technical Details

ELEGANT GLASS PARTITION FOR MAXIMUM TRANSPARENCY

The K-LITE 100 Demountable Architectural Office Partition is another superior range of K-LITE product that has a proven track record. It is based on a 100mm x 22mm glazing seal and bead with selection of door frame options.

Features

- Standard section : 100mm x 22mm
- Slim in design, the standard partition suite can be used with any stud thickness
- Suitable for 8mm / 10mm / 12mm toughened glass
- Single door frame sizes to allow for flush door 35mm or 45mm
- Partition height can be offered up to 3000mm
- Single glazed systems
- Sound insulation capacity of 32 - 34 dB

Door options

- Frame less glass, Stile glaze door, Timber or Sliding door system

Soild doors

- Timber doors can be of 44mm solid core in choice of veneers*

Door frames

- Aluminium full height up to 3000mm, doors are mounted on either of the hinges, pivots or sliding tracks. A range of Ironmongery can be supplied and incorporated with K-LITE 25 series.

Size limits

- K-LITE is designed for installation in areas up to nominal vertical panel size of 3000mm x 1200mm

Finish

- All exposed aluminium sections are Silver Anodized aluminium finish with 6063 T6 Grade

Assembly Characteristics

Glazed panels are hung onto a site installed framework of recessed head, side walls and base channels, studs and transoms.

Base tracks have a snap in profile for better installation of glass into section using beads made of silicone gel material and choice of junctions available. Assembly jig supplied ensures the speed accuracy of the installation and correct alignments of panel.

All panels can be removed independently of each other allowing replacement or variation at any time after initial installation.

Available in two colors

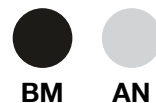

* Kindly consult with our team before placing order or confirmation

K-LITE 100

100mm x 22mm (single glaze)

Technical Details

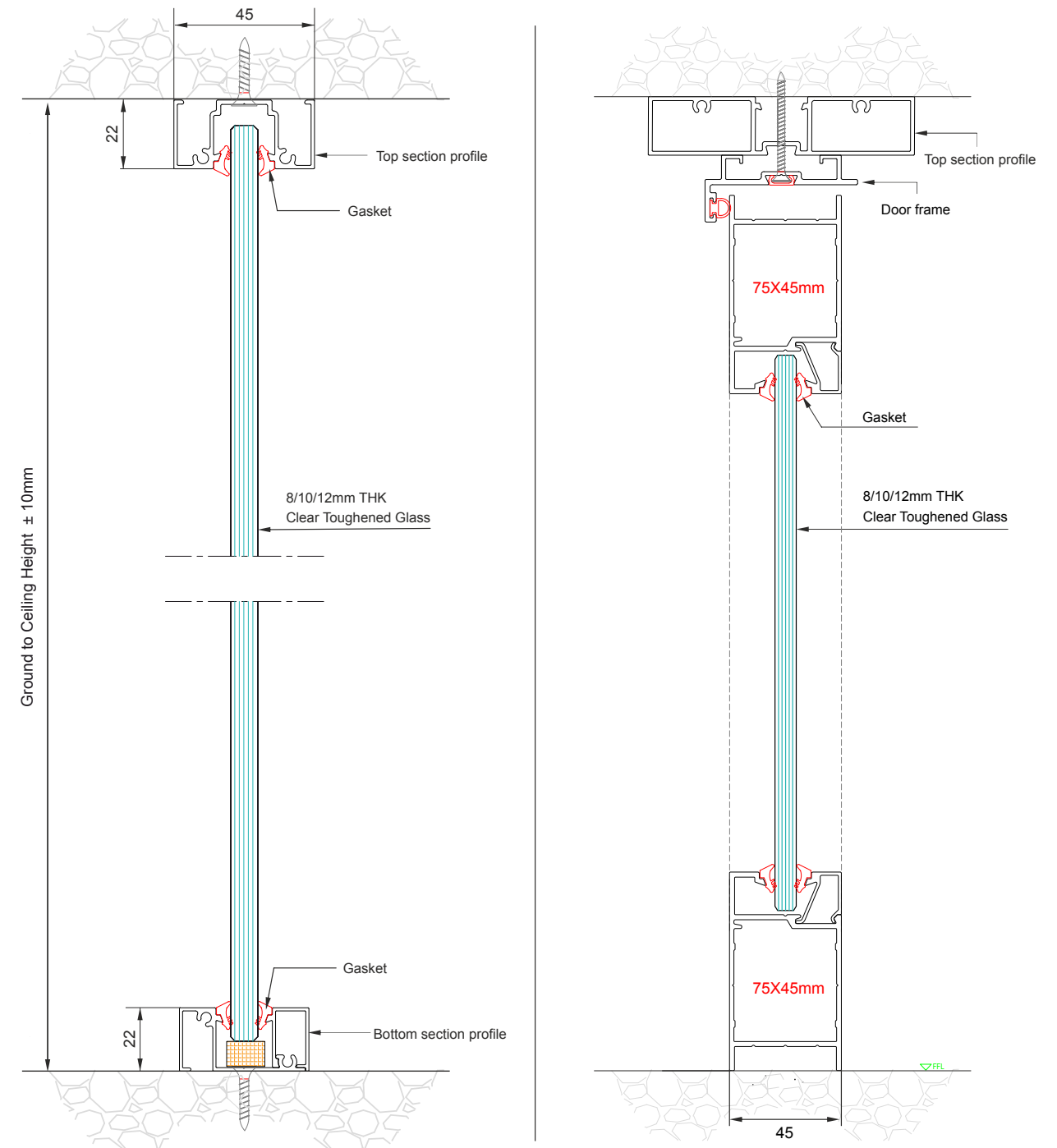

K-LITE 100

100mm x 22mm (single glaze)

SOPHISTICATED ARCHITECTURAL DESIGN OPTIONS

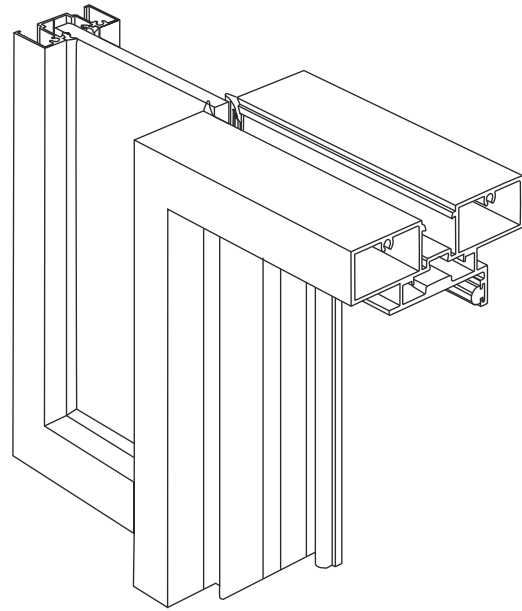

Single Glazed Partition - 100mm x 22mm

THESE ARE THE OPTIONS FOR JOINING GLASS AT I, L & T JUNCTIONS

Suitable for 8mm / 10mm / 12mm toughened glass.
The profiles feature a double-sided adhesive tape that guarantee a perfect structural union and sound insulation.

I JOINT

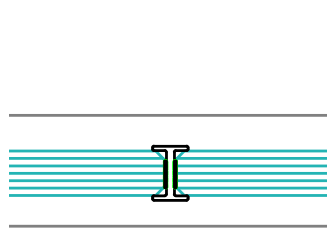

L JOINT

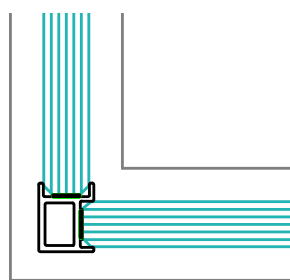

T JOINT

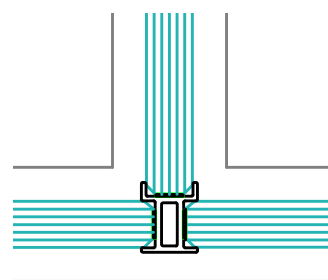

K-LITE 100

100mm x 22mm (single glaze)



K-LITE 100

100mm x 22mm

Door Configuration



K-LITE 45 Glazing with I joint and K-LITE 100 door frame.

Door :- Glass door with side hinges, Double D handle, bottom lock and Door closer.



K-LITE 45 Glazing with I joint and K-LITE 100 door frame.

Door :- Glass door with side hinges, D handle, bottom lock and Door closer.

K-LITE 100

100mm x 22mm

Door Configuration



K-LITE 45 Glazing with I joint and K-LITE 100 door frame.

Door :- Glass door with side hinges, H handle, Bottom lock and Door closer.



K-LITE 45 Glazing with I joint and K-LITE 100 door frame.

Door :- Glass door with side hinges, Studio lock and Door closer.



K-LITE 45 Glazing with Stickon and K-LITE 100 Door Frame.

Door :- Stile 75 on Hinges with Stickon and Mortise lock and handle



K-LITE 45 Glazing with I joint and K-LITE 100 Door Frame.

Door :- Stile 75 on Hinges with Mortise lock and handle

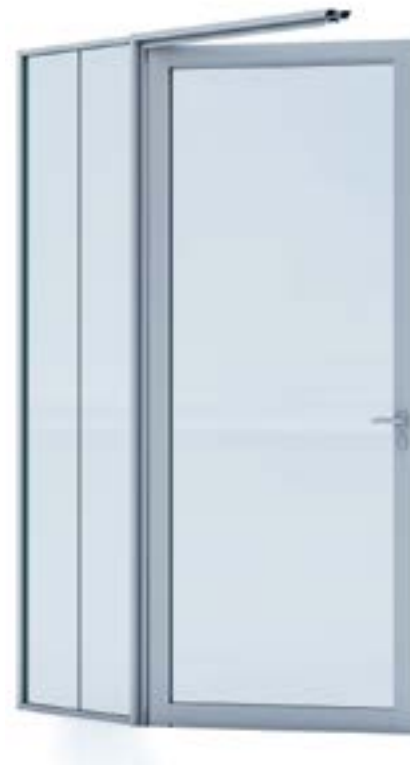

K-LITE 45 Glazing with Stickon and K-LITE 100 Door Frame.

Door :- Stile 75 on Hinges with Stickon and Mortise lock and handle

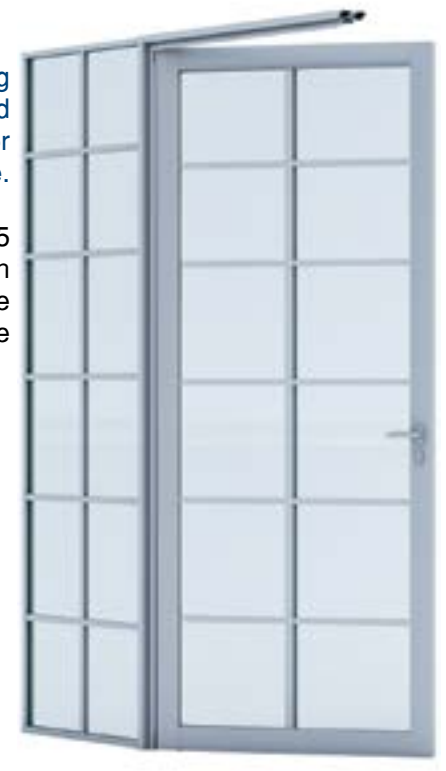

K-LITE 45 Glazing with I joint and K-LITE 100 Door Frame.

Door :- Stile 75 on Hinges with Mortise lock and handle

K-LITE 100

100mm x 22mm

Door Configuration



K-LITE 45 Glazing with I joint and K-LITE 100 door frame.

Door :- Glass door with Top-Bottom Pivot, Double D handle and Bottom lock

K-LITE 45 Glazing with I joint and K-LITE 100 door frame.

Door :- Glass door with Top-Bottom Pivot, D handle and Bottom lock



K-LITE 45 Glazing with I joint and K-LITE 100 door frame.

Door :- Glass door with Top-Bottom Pivot and Studio lock

K-LITE 45 Glazing with I joint and K-LITE 100 door frame.

Door :- Glass door with Top-Bottom Pivot, H handle and Bottom lock



K-LITE 100

100mm x 22mm

Door Configuration



K-LITE 45 Glazing with Stickon and K-LITE 100 Door Frame.

Door :- Wooden Door with hinges, H handle and Door Closer.

K-LITE 45 Glazing with I Joint and K-LITE 100 Door Frame.

Door :- Wooden Door with hinges, H handle and Door Closer.



K-LITE 100

100mm x 22mm

K-LITE 100 (100mmx22mm)

IMAGES	CODE	DESCRIPTION	UNIT	SIZE	COLOUR
	OZKL-45-001 2.5M AN OZKL-45-001 2.5M BM OZKL-45-001 3M AN OZKL-45-001 3M BM	K-LITE 45mm x 22mm Fix Profile	SET	2.5 Mtr. 2.5 Mtr. 3 Mtr. 3 Mtr.	● Silver Anodized ● Black Matt ● Silver Anodized ● Black Matt
	OZKL-45-002 3M AN OZKL-45-002 3M BM	K-LITE 45mm x 22mm Folding Profile	Pcs.	3 Mtr.	● Silver Anodized ● Black Matt
	OZKLST-001 3M AN OZKLST-001 3M BM	Stickon Profile	Pcs.	3 Mtr.	● Silver Anodized ● Black Matt
	OZKL-100-001 2.5M AN OZKL-100-001 2.5M BM OZKL-100-001 3M AN OZKL-100-001 3M BM	K-LITE 100 Door Frame Profile	Pcs.	2.5 Mtr. 2.5 Mtr. 3 Mtr. 3 Mtr.	● Silver Anodized ● Black Matt ● Silver Anodized ● Black Matt
	OZKL-PT-001 2.5M AN OZKL-PT-001 2.5M BM OZKL-PT-001 3M AN OZKL-PT-001 3M BM	Door Jamb for SD 60 and 35mm Solid Door	Pcs.	2.5 Mtr. 2.5 Mtr. 3 Mtr. 3 Mtr.	● Silver Anodized ● Black Matt ● Silver Anodized ● Black Matt
	OZKL-PT-002 2.5M AN OZKL-PT-002 2.5M BM OZKL-PT-002 3M AN OZKL-PT-002 3M BM	Door Jamb for SD 75 and 45mm Solid Door	Pcs.	2.5 Mtr. 2.5 Mtr. 3 Mtr. 3 Mtr.	● Silver Anodized ● Black Matt ● Silver Anodized ● Black Matt
	OZKL-100-005 3M AN OZKL-100-005 3M BM	Glass Clip For 100 x 100 Access Control Panel	Pcs.	3 Mtr.	● Silver Anodized ● Black Matt
	OZKL-100-002 3M AN OZKL-100-002 3M BM	100 x 100 Access Control Panel	Pcs.	3 Mtr.	● Silver Anodized ● Black Matt

● Gold Matt ● Champagne Matt ● Rose Gold Matt
*Finishes Available on Request

K-LITE 100

100mm x 22mm

K-LITE 100 (100mmx22mm)

IMAGES	CODE	DESCRIPTION	UNIT	SIZE	COLOUR
	OZKL-100-003 3M AN OZKL-100-003 3M BM	Cover Clip For 100 x 100 Access Control Panel	Pcs.	3 Mtr.	● Silver Anodized ● Black Matt
	OZKL-100-004 3M AN OZKL-100-004 3M BM	Flush Clip For 100 x 100 Access Control Panel	Pcs.	3 Mtr.	● Silver Anodized ● Black Matt
	OZKL-D60-101 2.5M AN OZKL-D60-101 2.5M BM OZKL-D60-101 3M AN OZKL-D60-101 3M BM	SD 60 Vertical Profile 60 x 35	Pcs.	2.5 Mtr. 2.5 Mtr. 3 Mtr. 3 Mtr.	● Silver Anodized ● Black Matt ● Silver Anodized ● Black Matt
	OZKL-D60-102 2.1M AN OZKL-D60-102 2.1M BM	SD 60 Top-Bottom Profile 60 x 35	Pcs.	2.1 Mtr.	● Silver Anodized ● Black Matt
	OZKL-D75-103 2.5M AN OZKL-D75-103 2.5M BM OZKL-D75-103 3M AN OZKL-D75-103 3M BM	SD 75 Vertical Profile 75 x 45	Pcs.	2.5 Mtr. 2.5 Mtr. 3 Mtr. 3 Mtr.	● Silver Anodized ● Black Matt ● Silver Anodized ● Black Matt
	OZKL-D75-104 2.1M AN OZKL-D75-104 2.1M BM	SD 75 Top-Bottom Profile 75 x 45	Pcs.	2.1 Mtr.	● Silver Anodized ● Black Matt
	OZKL-I-08 3M AN OZKL-I-08 3M BM	I Joint for 8mm glass	Pcs.	3 Mtr.	● Silver Anodized ● Black Matt
	OZKL-I-10 3M AN OZKL-I-10 3M BM	I Joint for 10mm glass	Pcs.	3 Mtr.	● Silver Anodized ● Black Matt

● Gold Matt ● Champagne Matt ● Rose Gold Matt
*Finishes Available on Request

K-LITE 100

100mm x 22mm

K-LITE 100 (100mmx22mm)

IMAGES	CODE	DESCRIPTION	UNIT	SIZE	COLOUR
	OZKL-I-12 3M AN OZKL-I-12 3M BM	I Joint for 12mm glass	Pcs.	3 Mtr.	● Silver Anodized ● Black Matt
	OZKL-L-08 3M AN OZKL-L-08 3M BM	L Joint for 8mm glass	Pcs.	3 Mtr.	● Silver Anodized ● Black Matt
	OZKL-L-10 3M AN OZKL-L-10 3M BM	L Joint for 10mm glass	Pcs.	3 Mtr.	● Silver Anodized ● Black Matt
	OZKL-L-12 3M AN OZKL-L-12 3M BM	L Joint for 12mm glass	Pcs.	3 Mtr.	● Silver Anodized ● Black Matt
	OZKL-T-08 3M AN OZKL-T-08 3M BM	T Joint for 8mm glass	Pcs.	3 Mtr.	● Silver Anodized ● Black Matt
	OZKL-T-10 3M AN OZKL-T-10 3M BM	T Joint for 10mm glass	Pcs.	3 Mtr.	● Silver Anodized ● Black Matt
	OZKL-T-12 3M AN OZKL-T-12 3M BM	T Joint for 12mm glass	Pcs.	3 Mtr.	● Silver Anodized ● Black Matt
	OZKL-GASKET-001 GR OZKL-GASKET-001 BK	Used for Door Frame Profile	RMTR	1 Mtr.	● Grey ● Black

● Gold Matt ● Champagne Matt ● Rose Gold Matt
*Finishes Available on Request

K-LITE 100

100mm x 22mm

K-LITE 100 (100mmx22mm)





IMAGES	CODE	DESCRIPTION	UNIT	SIZE	COLOUR
	OZKL-GASKET-002-08 GR OZKL-GASKET-002-08 BK	Gasket for 8mm glass	RMTR	1 Mtr.	● Grey ● Black
	OZKL-GASKET-004-10 GR OZKL-GASKET-004-10 BK	Gasket for 10mm glass	RMTR	1 Mtr.	● Grey ● Black
	OZKL-GASKET-003-12 GR OZKL-GASKET-003-12 BK	Gasket for 12mm glass	RMTR	1 Mtr.	● Grey ● Black
	OZKL-GASKET-005 GR OZKL-GASKET-005 BK	Gasket for Door Jamb	RMTR	1 Mtr.	● Grey ● Black
	OZKL-ACC-001	Corner Connector for Door Jamb	Pcs.	1	
	OZKL-ACC-002	Corner Connector for Glazing Profile	Pcs.	1	
	OZKL-ACC-003	Threaded Rod for Door 1mtr	SET		
	OZKL-ACC-004	Threaded Rod for Door 2mtr	SET		

● Gold Matt ● Champagne Matt ● Rose Gold Matt
*Finishes Available on Request

K-LITE 100

100mm x 22mm

K-LITE 100 (100mmx22mm)

IMAGES	CODE	DESCRIPTION	UNIT	SIZE	COLOUR
	OZKL-ACC-005	Corner Joint for SD 75 when using Door Closer	Pcs.		
	OZKLFT 10MMx1MMx10M	Acoustical Single Side Foam Tape	ROLL		
	OZKLCT 6MMx1MMx10M	Double Sided Acrylic Clear Tape used for I, L, T Joint	ROLL		
	OZKLCT 18MMx0.8MMx10M	Double Sided Acrylic Clear Tape used for BrooOZKLyn Profile	ROLL		

K-LITE 100

100mm x 22mm



● Gold Matt ● Champagne Matt ● Rose Gold Matt
*Finishes Available on Request

K-LITE EF 75 SG

75mm x 30mm (single glaze)

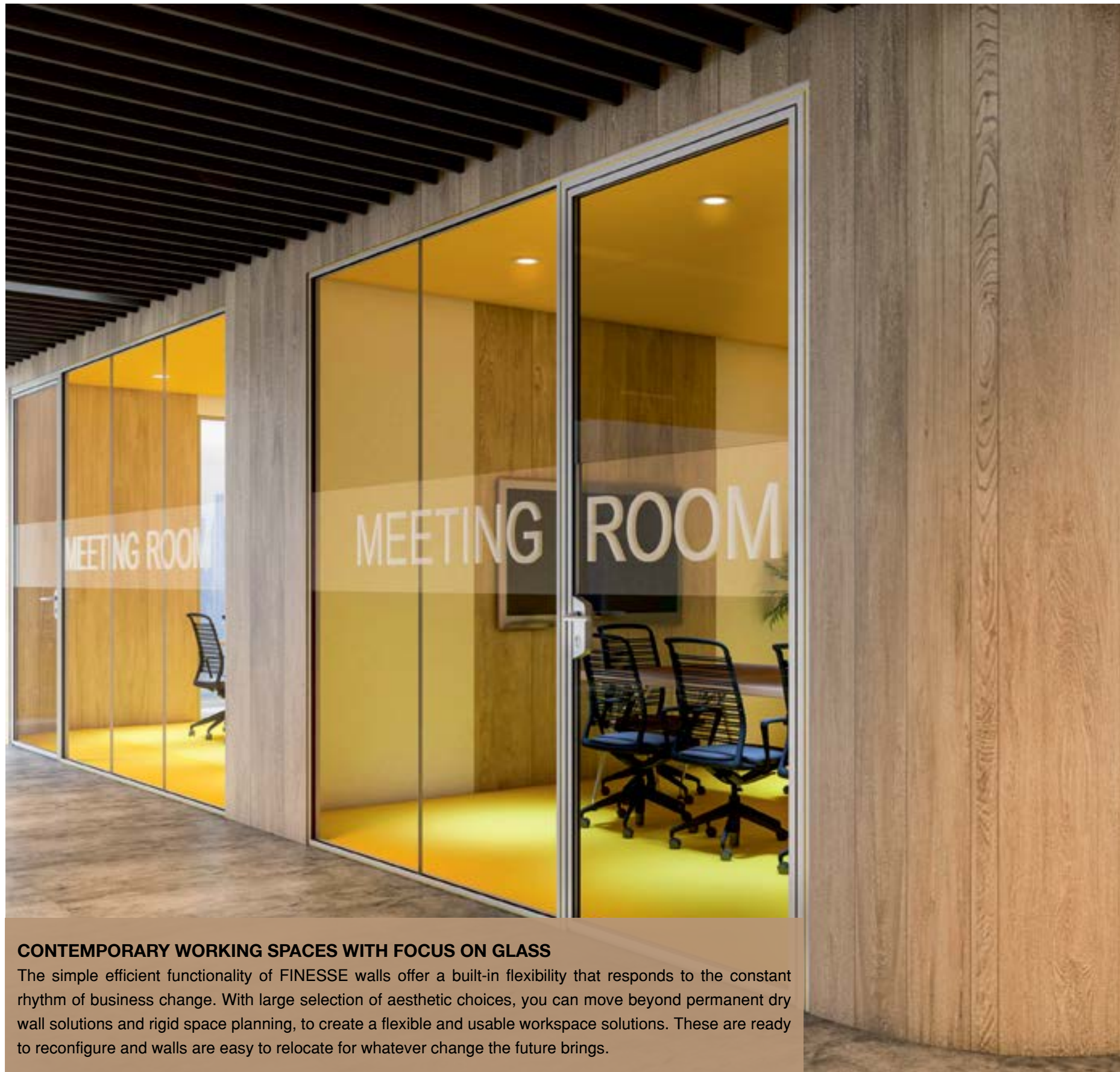

CONTEMPORARY WORKING SPACES WITH FOCUS ON GLASS

The simple efficient functionality of FINESSE walls offer a built-in flexibility that responds to the constant rhythm of business change. With large selection of aesthetic choices, you can move beyond permanent dry wall solutions and rigid space planning, to create a flexible and usable workspace solutions. These are ready to reconfigure and walls are easy to relocate for whatever change the future brings.

K-LITE EF 75 SG

75mm x 30mm (single glaze)



K-LITE EF 75 SG

75mm x 30mm (single glaze)

Technical Specification

CONTEMPORARY WORKING SPACES WITH FOCUS ON GLASS

The simple efficient functionality of K-LITE EF walls offer a built-in flexibility that responds to the constant rhythm of business change. With large selection of aesthetic choices, you can move beyond permanent dry wall solutions and rigid space planning, to create a flexible and usable workspace solutions. These are ready to reconfigure and walls are easy to relocate for whatever change the future brings.

Features

- Demountable glass partition, 75mm thick
- Maximum height : 3000mm (depending on elevations), for bigger heights, reinforcement of the structure required
- Aluminium Profiles : AN/BM Silver Anodized or RAL powder-coated
- Any configuration possible : Full height, Segmented, Segmented at door height, multi-transoms, etc.
- Cove visibility of 10mm on top and bottom
- Glazing seal (Gasket) available : BM & White
- Glass of 5mm or 6mm can be used according to the requirement

Hinged doors

- Laminated wooden door
- Aluminium-framed glass door

Options and accessories

- Blinds with horizontal or vertical slats
- Integration of light switches into the door jamb
- Automatic drop seal for wood, aluminium framed and glass doors
- Concealed door closer

Acoustics

- Glass wall : STC = from 38 to 44 dB
- Door set : STC = from 34 to 38 dB

Size limits

- Designed for installation in areas up to nominal vertical panel size of 3000mm x 1200mm

Finish

- All exposed aluminium section are Silver Anodized aluminium finish with 6063 T6 Grade

Assembly Characteristics

Glazed panels are hung onto a site installed framework of recessed head, side walls and base channels, studs and transoms.

Base tracks have a snap in profile for better installation of glass into section using beads made of silicone gel material and choice of junctions available. Assembly jig supplied ensures the speed and accuracy of the installation and correct alignments of the panel. All panels can be removed independently of each other allowing replacement or variation at any time after initial installation.

Available in two colors

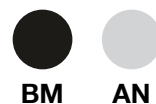

K-LITE EF 75 SG

75mm x 30mm (single glaze)

Single Glaze Option

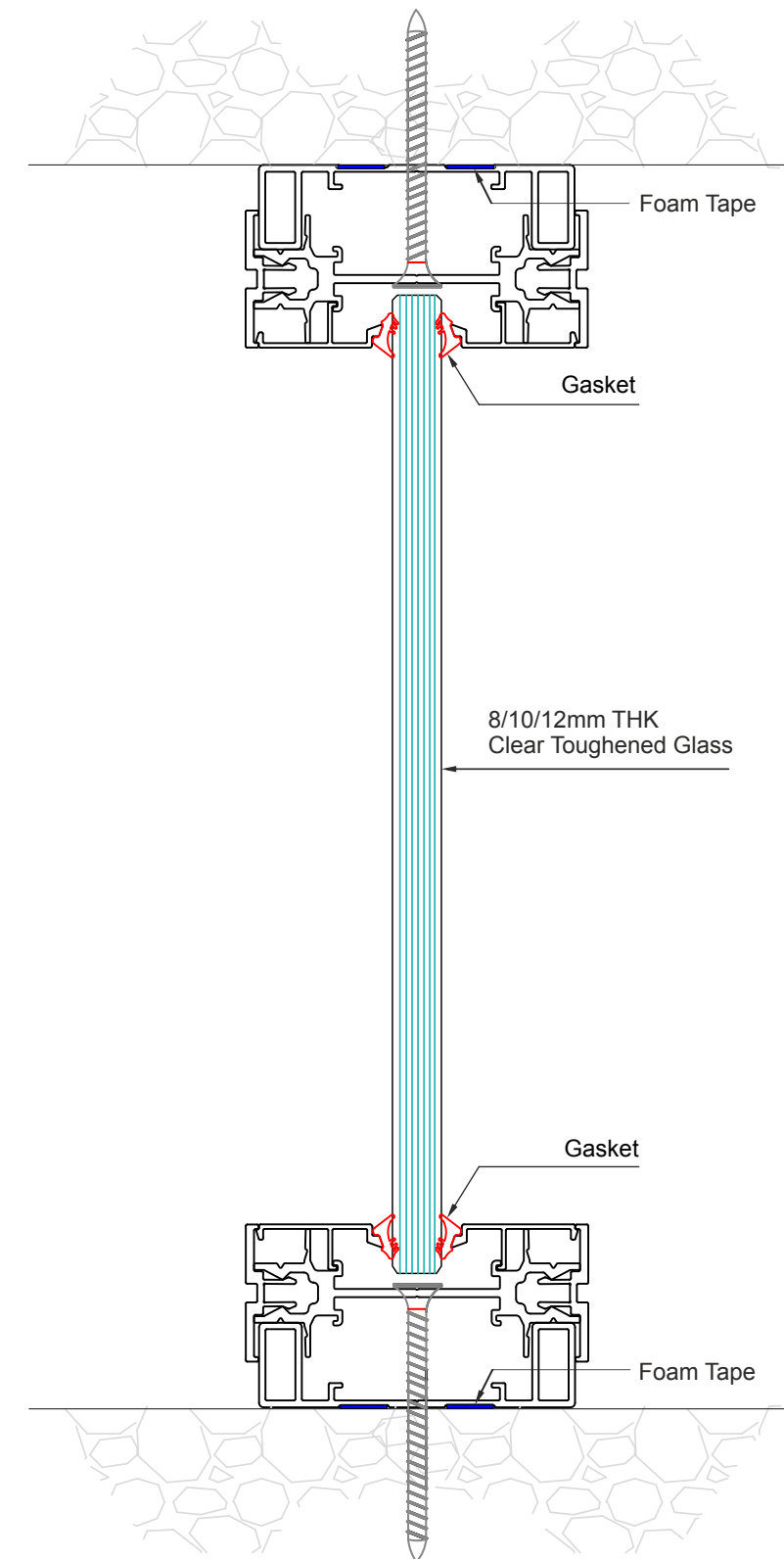

K-LITE EF 75 DG

75mm x 30mm (Double glaze)



CONTEMPORARY WORKING SPACES WITH FOCUS ON GLASS

The simple efficient functionality of FINESSE walls offer a built-in flexibility that responds to the constant rhythm of business change. With large selection of aesthetic choices, you can move beyond permanent dry wall solutions and rigid space planning, to create a flexible and usable workspace solutions. These are ready to reconfigure and walls are easy to relocate for whatever change the future brings.

K-LITE EF 75 DG

75mm x 30mm (Double glaze)

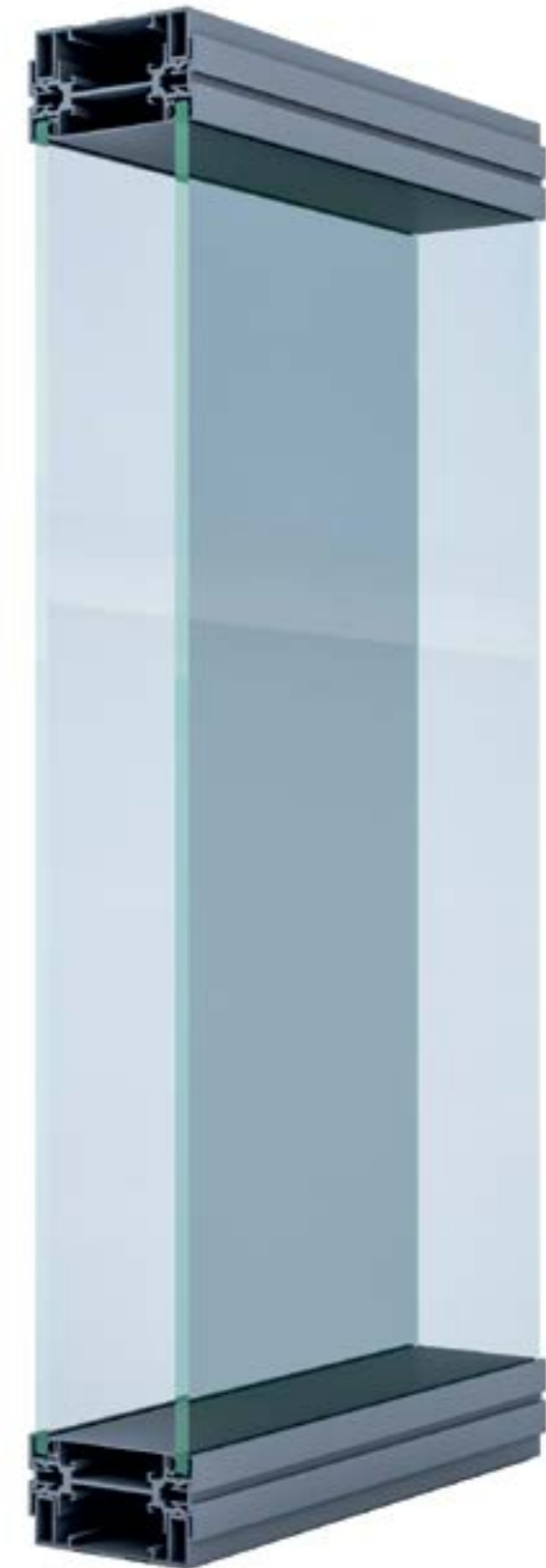

K-LITE EF 75 DG

75mm x 30mm (Double glaze)

Technical Specification

CONTEMPORARY WORKING SPACES WITH FOCUS ON GLASS

The simple efficient functionality of K-LITE EF walls offer a built-in flexibility that responds to the constant rhythm of business change. With large selection of aesthetic choices, you can move beyond permanent dry wall solutions and rigid space planning, to create a flexible and usable workspace solutions. These are ready to reconfigure and walls are easy to relocate for whatever change the future brings.

Features

- Demountable glass partition, 75mm thick
- Maximum height : 3000mm (depending on elevations), for bigger heights, reinforcement of the structure required
- Aluminium Profiles : AN/BM Silver Anodized or RAL powder-coated
- Any configuration possible : Full height, Segmented, Segmented at door height, multi-transoms, etc.
- Cove visibility of 10mm on top and bottom
- Glazing seal (Gasket) available : BM & White
- Glass of 5mm or 6mm can be used according to the requirement

Hinged doors

- Laminated wooden door
- Aluminium-framed glass door

Options and accessories

- Blinds with horizontal or vertical slats
- Integration of light switches into the door jamb
- Automatic drop seal for wood, aluminium framed and glass doors
- Concealed door closer

Acoustics

- Glass wall : STC = from 30 to 35 dB
- Door set : STC = from 28 to 30 dB

Size limits

- Designed for installation in areas up to nominal vertical panel size of 3000mm x 1200mm

Finish

- All exposed aluminium section are Silver Anodized aluminium finish with 6063 T6 Grade

Assembly Characteristics

Glazed panels are hung onto a site installed framework of recessed head, side walls and base channels, studs and transoms.

Base tracks have a snap in profile for better installation of glass into section using beads made of silicone gel material and choice of junctions available. Assembly jig supplied ensures the speed and accuracy of the installation and correct alignments of the panel. All panels can be removed independently of each other allowing replacement or variation at any time after initial installation.

Available in two colors

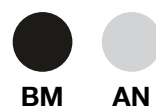

K-LITE EF 75 DG

75mm x 30mm (Double glaze)

Double Glaze Option

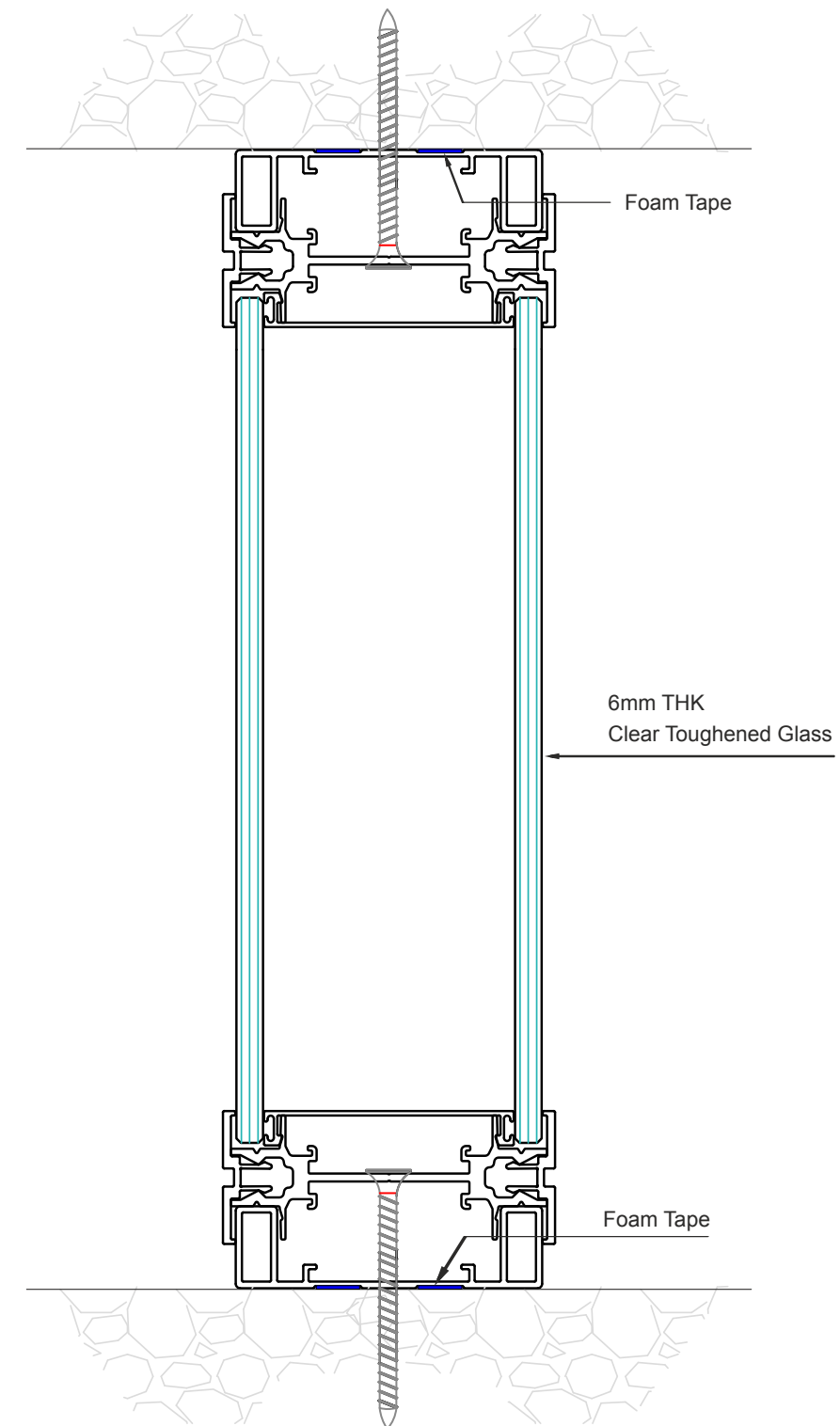

K-LITE EF 75 WD

75mm x 30mm (Wooden)



CONTEMPORARY WORKING SPACES WITH FOCUS ON GLASS

The simple efficient functionality of FINESSE walls offer a built-in flexibility that responds to the constant rhythm of business change. With large selection of aesthetic choices, you can move beyond permanent dry wall solutions and rigid space planning, to create a flexible and usable workspace solutions. These are ready to reconfigure and walls are easy to relocate for whatever change the future brings.

K-LITE EF 75 WD

75mm x 30mm (Wooden)

Technical Specification

CONTEMPORARY WORKING SPACES WITH FOCUS ON GLASS

The simple efficient functionality of K-LITE EF walls offer a built-in flexibility that responds to the constant rhythm of business change. With large selection of aesthetic choices, you can move beyond permanent dry wall solutions and rigid space planning, to create a flexible and usable workspace solutions. These are ready to reconfigure and walls are easy to relocate for whatever change the future brings.

Features

- Demountable glass partition, 75mm thick
- Maximum height : 3000mm (depending on elevations), for bigger heights, reinforcement of the structure required
- Aluminium Profiles : AN/BM Silver Anodized or RAL powder-coated
- Any configuration possible : Full height, Segmented, Segmented at door height, multi-transoms, etc.
- Cove visibility of 10mm on top and bottom
- Glazing seal (Gasket) available : BM & White
- Glass of 5mm or 6mm can be used according to the requirement

Hinged doors

- Laminated wooden door
- Aluminium-framed glass door

Options and accessories

- Blinds with horizontal or vertical slats
- Integration of light switches into the door jamb
- Automatic drop seal for wood, aluminium framed and glass doors
- Concealed door closer

Acoustics

- Glass wall : STC = from 30 to 35 dB
- Door set : STC = from 28 to 30 dB

Size limits

- Designed for installation in areas up to nominal vertical panel size of 3000mm x 1200mm

Finish

- All exposed aluminium section are Silver Anodized aluminium finish with 6063 T6 Grade

Assembly Characteristics

Glazed panels are hung onto a site installed framework of recessed head, side walls and base channels, studs and transoms.

Base tracks have a snap in profile for better installation of glass into section using beads made of silicone gel material and choice of junctions available. Assembly jig supplied ensures the speed and accuracy of the installation and correct alignments of the panel. All panels can be removed independently of each other allowing replacement or variation at any time after initial installation.

Available in two colors



K-LITE EF 75 WD

75mm x 30mm (Wooden)

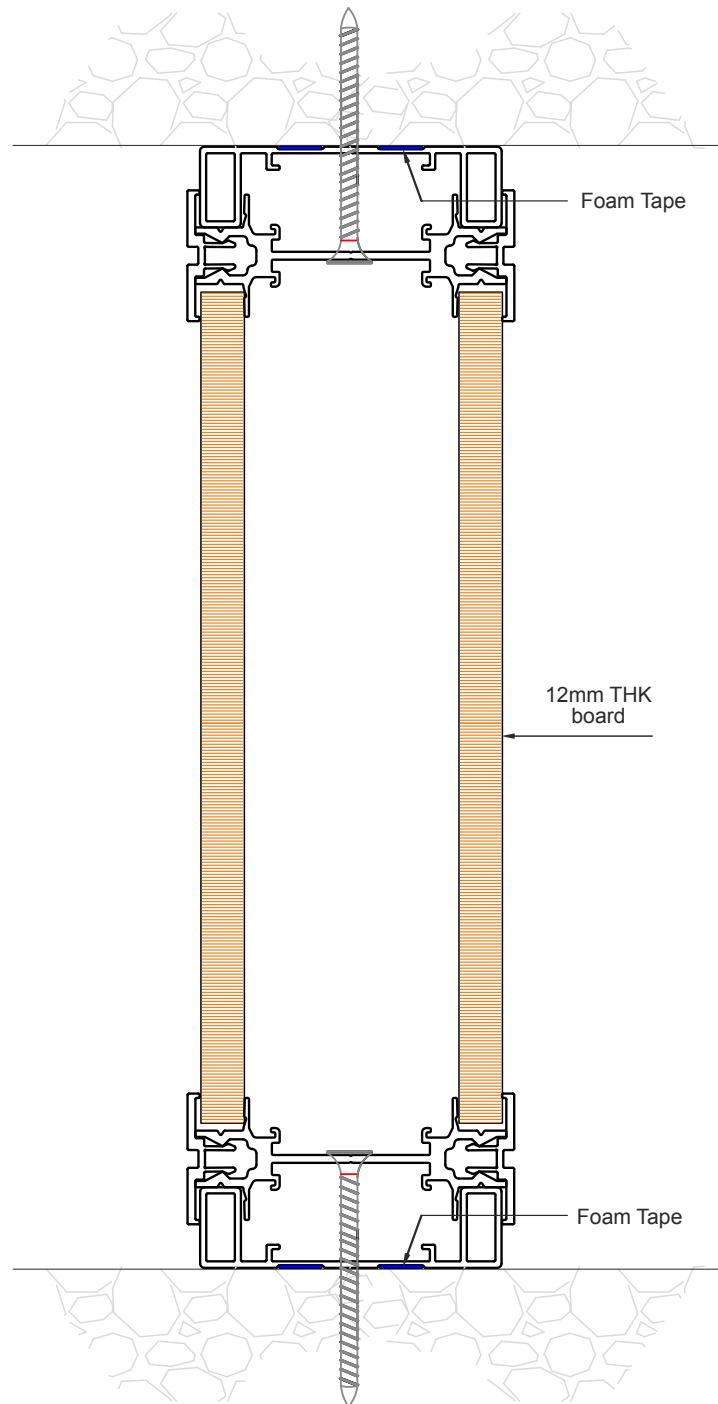

K-LITE EF 75

75mm x 30mm



K-LITE EF 75
Glazing with
segmented partition.

Door :- Glass door
with side hinges, D
handle, bottom lock
and Door closer.

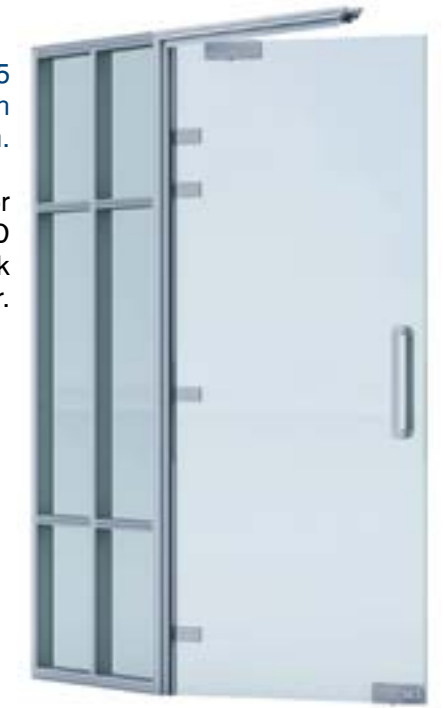

K-LITE EF 75
Glazing with
segmented partition.

Door :- Glass door
with side hinges,
Studio lock and
Door closer.



K-LITE EF 75
Glazing with
segmented partition.

Door :- Glass door
with side hinges, H
handle, bottom lock
and Door closer.

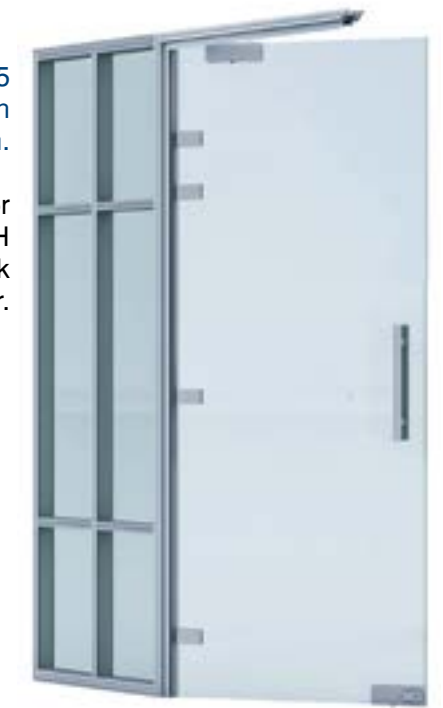

K-LITE EF 75
Glazing with
segmented partition.

Door :- Glass door
with side hinges,
Double D handle,
bottom lock and
Door closer.

K-LITE EF 75

75mm x 30mm



K-LITE EF 75
Glazing with
segmented partition.

Door :- Stile 75
on Hinges with
Mortise lock and
handle



K-LITE EF 75
Glazing with
segmented partition.

Door :- Stile 60 on
Hinges with Mortise
lock and handle

K-LITE EF 75

75mm x 30mm



K-LITE EF 75
Glazing with
segmented partition.

Door :- Glass door
with Top-Bottom
Pivot, H handle and
Bottom lock.



Ecofinesse Glazing
with segmented
partition.

Door :- Glass door
with Top-Bottom
Pivot, D handle and
Bottom lock.



K-LITE EF 75
Glazing with
segmented partition.

Door :- Glass door
with Top-Bottom
Pivot, Double D
handle and
Bottom lock.



K-LITE EF 75
Glazing with
segmented partition.

Door :- Glass door
with Top-Bottom
Pivot and Studio
lock



K-LITE EF 75
Glazing with
segmented partition.

Door :- Glass door
with Side hinges,
Door closer,
H handle and
Bottom lock.



K-LITE EF 75
Glazing with
segmented partition.

Door :- Wooden
Door with hinges,
H handle and Door
Closer.

K-LITE EF 75

75mm x 30mm



K-LITE EF 75
Glazing with
segmented partition.

Door :- Glass door
with Side hinges,
Door closer,
Double D handle
and Bottom lock.

K-LITE EF 75
Glazing with
segmented partition.

Door :- Glass door
with Side hinges,
Studio Lock and
Door closer



K-LITE EF 75
Glazing with
segmented partition.

Door :- Glass door
with Top-Bottom
Pivot and Studio
Lock

K-LITE EF 75
Glazing with
segmented partition.

Door :- Glass door
with Side hinges,
Door closer,
D handle and
Bottom lock.

K-LITE EF 75

75mm x 30mm



K-LITE EF 75
Glazing with
segmented partition.

Door :- Stile 75
on Hinges with
Mortise lock and
handle

K-LITE EF 75
Glazing with
segmented partition.

Door :- Stile 60 on
Hinges with Mortise
lock and handle



K-LITE EF 75
Glazing with
segmented partition.

Door :- Glass door
with Top-Bottom
Pivot, H handle and
Bottom lock.

K-LITE EF 75
Glazing with
segmented partition.

Door :- Glass door
with Top-Bottom
Pivot, Double D
handle and Bottom
lock.



K-LITE EF 75

75mm x 30mm



K-LITE EF 75
Glazing with
segmented partition.

Door :- Glass door
with Top-Bottom
Pivot, D handle and
Bottom lock.



K-LITE EF 75
Glazing with
segmented partition.

Door :- Wooden
Door with hinges,
H handle and Door
Closer.

K-LITE EF 75

75mm x 30mm



K-LITE EF
75Glazing with
segmented partition.

Door :- Glass door
with side hinges,
D handle, bottom
lock and Door
closer.



K-LITE EF 75
Glazing with
segmented partition.

Door :- Glass door
with side hinges,
Double D handle,
bottom lock and
Door closer.

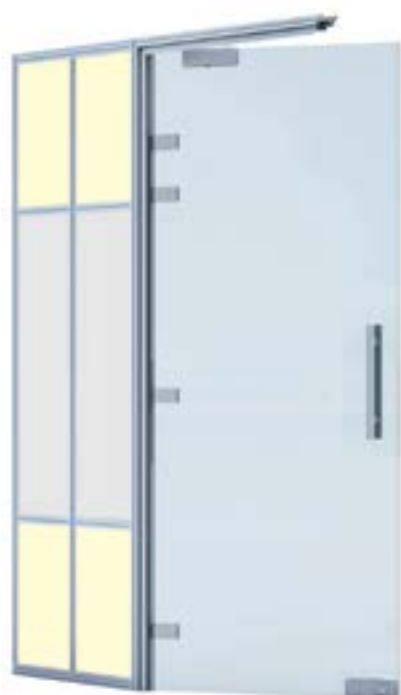

K-LITE EF 75
Glazing with
segmented partition.

Door :- Glass door
with side hinges,
Studio lock and
Door closer.

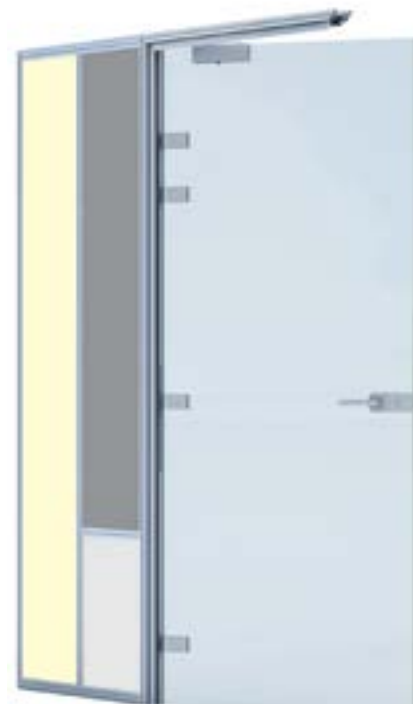

K-LITE EF 75
Glazing with
segmented partition.

Door :- Glass door
with side hinges, H
handle, bottom lock
and Door closer.



K-LITE EF 75
Glazing with
segmented partition.

Door :- Stile 75
on Hinges with
Mortise lock and
handle



K-LITE EF 75
Glazing with
segmented partition.

Door :- Stile 60
on Hinges with
Mortise lock and
handle

K-LITE EF 75

75mm x 30mm



K-LITE EF 75
Glazing with
segmented partition.

Door :- Glass door
with Top-Bottom
Pivot, Double D
handle and
Bottom lock.

K-LITE EF 75
Glazing.

Door :- Glass door
with Top-Bottom
Pivot and Studio
Lock



K-LITE EF 75

75mm x 30mm



K-LITE EF 75
Glazing

Door :- Wooden
Door with hinges,
H handle and
Door Closer.

K-LITE EF 75
Glazing with
segmented partition.

Door :- Wooden
Door with hinges,
H handle and Door
Closer.



K-LITE EF 75
Glazing.

Door :- Glass door
with Top-Bottom
Pivot, D handle and
Bottom Lock

K-LITE EF 75
Glazing with
segmented partition.

Door :- Glass door
with Top-Bottom
Pivot, H handle and
Bottom Lock



K-LITE EF 75

75mm x 30mm

K-LITE 75 (75mmx30mm)

IMAGES	CODE	DESCRIPTION	UNIT	SIZE	COLOUR
	OZKLEF-001 3M AN OZKLEF-001 3M BM	Top-Bottom Levelling Profile	Pcs.	3 Mtr.	● Silver Anodized ● Black Matt
	OZKLEF-002 3.05M MILL	Mullion	Pcs.	Mill	● Silver Anodized ● Black Matt
	OZKLST-001 3M AN OZKLST-001 3M BM	Stickon Profile	Pcs.	3 Mtr.	● Silver Anodized ● Black Matt
	OZKLEF-003 3M AN OZKLEF-003 3M BM	Common Outer Clip	Pcs.	3 Mtr.	● Silver Anodized ● Black Matt
	OZKLEF-004 3M AN OZKLEF-004 3M BM	Single Glaze Clip	Pcs.	3 Mtr.	● Silver Anodized ● Black Matt
	OZKLEF-005 3M AN OZKLEF-005 3M BM	Double Glaze Clip	Pcs.	3 Mtr.	● Silver Anodized ● Black Matt
	OZKL-PT-001 2.5M AN OZKL-PT-001 2.5M BM OZKL-PT-001 3M AN OZKL-PT-001 3M BM	Door Jamb for SD 60 and 35mm Solid Door	Pcs.	2.5 Mtr. 2.5 Mtr. 3 Mtr. 3 Mtr.	● Silver Anodized ● Black Matt ● Silver Anodized ● Black Matt
	OZKL-PT-002 2.5M AN OZKL-PT-002 2.5M BM OZKL-PT-002 3M AN OZKL-PT-002 3M BM	Door Jamb for SD 75 and 45mm Solid Door	Pcs.	2.5 Mtr. 2.5 Mtr. 3 Mtr. 3 Mtr.	● Silver Anodized ● Black Matt ● Silver Anodized ● Black Matt

● Gold Matt ● Champagne Matt ● Rose Gold Matt
*Finishes Available on Request

K-LITE EF 75

75mm x 30mm

K-LITE 75 (75mmx30mm)

IMAGES	CODE	DESCRIPTION	UNIT	SIZE	COLOUR
	OZKL-D60-101 2.5M AN OZKL-D60-101 2.5M BM OZKL-D60-101 3M AN OZKL-D60-101 3M BM	SD 60 Vertical Profile 60 x 35	Pcs.	2.5 Mtr. 2.5 Mtr. 3 Mtr. 3 Mtr.	● Silver Anodized ● Black Matt ● Silver Anodized ● Black Matt
	OZKL-D60-102 2.1M AN OZKL-D60-102 2.1M BM	SD 60 Top-Bottom Profile 60 x 35	Pcs.	2.1 Mtr.	● Silver Anodized ● Black Matt
	OZKL-D75-103 2.5M AN OZKL-D75-103 2.5M BM OZKL-D75-103 3M AN OZKL-D75-103 3M BM	SD 75 Vertical Profile 75 x 45	Pcs.	2.5 Mtr. 2.5 Mtr. 3 Mtr. 3 Mtr.	● Silver Anodized ● Black Matt ● Silver Anodized ● Black Matt
	OZKL-D75-104 2.1M AN OZKL-D75-104 2.1M BM	SD 75 Top-Bottom Profile 75 x 45	Pcs.	2.1 Mtr.	● Silver Anodized ● Black Matt
	OZKL-I-08 3M AN OZKL-I-08 3M BM	I Joint for 8mm glass	Pcs.	3 Mtr.	● Silver Anodized ● Black Matt
	OZKL-I-10 3M AN OZKL-I-10 3M BM	I Joint for 10mm glass	Pcs.	3 Mtr.	● Silver Anodized ● Black Matt
	OZKL-I-12 3M AN OZKL-I-12 3M BM	I Joint for 12mm glass	Pcs.	3 Mtr.	● Silver Anodized ● Black Matt
	OZKL-L-08 3M AN OZKL-L-08 3M BM	L Joint for 8mm glass	Pcs.	3 Mtr.	● Silver Anodized ● Black Matt

● Gold Matt ● Champagne Matt ● Rose Gold Matt
*Finishes Available on Request

K-LITE EF 75

75mm x 30mm

K-LITE 75 (75mmx30mm)

IMAGES	CODE	DESCRIPTION	UNIT	SIZE	COLOUR
	OZKL-L-10 3M AN OZKL-L-10 3M BM	L Joint for 10mm glass	Pcs.	3 Mtr.	● Silver Anodized ● Black Matt
	OZKL-L-12 3M AN OZKL-L-12 3M BM	L Joint for 12mm glass	Pcs.	3 Mtr.	● Silver Anodized ● Black Matt
	OZKL-T-08 3M AN OZKL-T-08 3M BM	T Joint for 8mm glass	Pcs.	3 Mtr.	● Silver Anodized ● Black Matt
	OZKL-T-10 3M AN OZKL-T-10 3M BM	T Joint for 10mm glass	Pcs.	3 Mtr.	● Silver Anodized ● Black Matt
	OZKL-T-12 3M AN OZKL-T-12 3M BM	T Joint for 12mm glass	Pcs.	3 Mtr.	● Silver Anodized ● Black Matt
	OZKL-GASKET-001 GR OZKL-GASKET-001 BK	Used for Door Frame Profile	RMTR	1	● Grey ● Black
	OZKL-GASKET-002-08 GR OZKL-GASKET-002-08 BK	Gasket for 8mm glass	RMTR	1	● Grey ● Black
	OZKL-GASKET-004-10 GR OZKL-GASKET-004-10 BK	Gasket for 10mm glass	RMTR	1	● Grey ● Black

● Gold Matt ● Champagne Matt ● Rose Gold Matt
*Finishes Available on Request

K-LITE EF 75

75mm x 30mm

K-LITE 75 (75mmx30mm)

IMAGES	CODE	DESCRIPTION	UNIT	SIZE	COLOUR
	OZKL-GASKET-003-12 GR OZKL-GASKET-003-12 BK	Gasket for 12mm glass	RMTR	3 Mtr.	● Grey ● Black
	OZKL-GASKET-005 GR OZKL-GASKET-005 BK	Gasket for Door Jamb	RMTR	3 Mtr.	● Grey ● Black
	OZKL-ACC-001	Corner Connector for Door Jamb	Pcs.	1	
	OZKL-ACC-002	Corner Connector for Glazing Profile	Pcs.	1	
	OZKL-ACC-003	Threaded Rod for Door 1mtr	SET		
	OZKL-ACC-004	Threaded Rod for Door 2mtr	SET		
	OZKL-ACC-005	Corner Joint for SD 75 when using Door Closer	Pcs.		
	OZKLFT 10MMx1MMx10M	Acoustical Single Side Foam Tape	Roll		
	OZKLCT 6MMx1MMx10M	Double Sided Acrylic Clear Tape used for I, L, T Joint	Roll		
	OZKLCT 18MMx0.8MMx10M	Double Sided Acrylic Clear Tape used for BrooOZKLyn Profile	Roll		

● Gold Matt ● Champagne Matt ● Rose Gold Matt
*Finishes Available on Request

HARDWARE ACCESSORIES

NY Glazing HARDWARE

IMAGES	CODE	DESCRIPTION	UNIT	SIZE	COLOUR
	OZ-PGDH STD SSS OZ-PGDH STD BM	For glass thickness : 10mm to 12mm Max. door weight : 80 Kgs / Pair Max. door width : 900mm Max. door height : 2400mm SSS/BM finish.	SET		● SSS ● Black Matt
	OZ-DP1/2-GDL STD AN OZ-DP1/2-GDL STD BM	For glass thickness : 10mm to 12mm AN/BM finish. Material : SUS 304	SET		● Silver Anodized ● Black Matt
	OPL-1P STD SS OPL-1P STD BM	For glass thickness : 10mm to 12mm SSS/ BM finish. Material : Alloy	SET		● SSS ● Black Matt
	OMH-11LN STD SSS OMH-11LN STD BM	Lever Handle For Framed Door & Flush Door SSS/ BM finish. Material : SUS 304	SET		● SSS ● Black Matt
	OMH-33N STD SSS OMH-33N STD BM	Lever Handle For Framed Door & Flush Door SSS/ BM finish. Material : SUS 304	SET		● SSS ● Black Matt
	OGH-55 32x457MM SSS OGH-55 32x457MM BM OGH-55 32x457MM SSS OGH-55 32x457MM BM	For glass thickness : 10mm to 12mm SSS/BM finish. Material : SUS 304	SET		● SSS ● Black Matt ● SSS ● Black Matt
	OGH-11 25X325 SSS OGH-11 25X325 BM OGH-11 25X450 SSS OGH-11 25X450 BM OGH-11 32X600 SSS OGH-11 32X600 BM	For glass thickness : 10mm to 12mm SSS/BM finish. Material : SUS 304	SET		● SSS ● Black Matt ● SSS ● Black Matt ● SSS ● Black Matt

● Gold Matt ● Champagne Matt ● Rose Gold Matt
*Finishes Available on Request

HARDWARE ACCESSORIES

NY Glazing HARDWARE

IMAGES	CODE	DESCRIPTION	UNIT	SIZE	COLOUR
	OGH-OFS-11 25X325MM SSS OGH-OFS-11 25X325MM BM OGH-OFS-11 25X475MM SSS OGH-OFS-11 25X475MM BM OGH-OFS-11 25X625MM SSS OGH-OFS-11 25X625MM BM)	For glass thickness : 10mm to 12mm SSS/BM finish. Material : SUS 304	SET		● SSS ● Black Matt ● SSS ● Black Matt ● SSS ● Black Matt
	OMC-22-K2K-N2 60MM SN OMC-22-K2K-N2 60MM BM OMC-22-K2K-N2 70MM SN OMC-22-K2K-N2 70MM BM	Key to Key Cylinder Length/ Size : 60mm Material : SS SUS 304 Supplied with 5 Keys computerized Finish : SN/BM	SET		● Satin Nickel ● Black Matt ● Satin Nickel ● Black Matt
	OMC-22-K2N-N2 60MM SN OMC-22-K2N-N2 60MM BM OMC-22-K2N-N2 70MM SN OMC-22-K2N-N2 70MM BM	Key to Knob Cylinder Length/ Size : 60mm / 70mm Material : SS SUS 304 Supplied with 5 Keys computerized Finish : SN/BM	SET		● Satin Nickel ● Black Matt ● Satin Nickel ● Black Matt
	OZ-DST-11 STD SN OZ-DST-11 STD BM	Half moon type Door Stopper Material : SS SUS 304 Finish : SSS/BM	Pcs.		● SSS ● Black Matt
	NSK-780 STD SILVER NSK-780 STD BM	Overhead Rack & Pinion Door Closer with Scissor/Cross Arm Maximum Door Weight 80 Kg. Maximum Door Width 950mm. 500,000 Cycles Tested EN 2-5 EN 1154, CE Certified, UL Listed Finish : AN/BM	Pcs.		● Silver Anodized ● Black Matt
	CDC-3800-SL TA SILVER CDC-3800-SL TA BM	Rack and Pinion Concealed Door Closer with Hold Open Function and Closing Force EN 3 Identical design for DIN left and DIN right Length - 229mm, Width - 28mm, Height - 70mm Closing force adjustable - 110-0 Latching action adjustable - 15-0 Finish: AN/BM	Pcs.		● Silver Anodized ● Black Matt
	CDC-CA-6800-SL TA SILVER CDC-CA-6800-SL TA BM	Cam Action Concealed Door Closer with Hold Open Function and Adjustable Closing Force EN 2-4 Identical design for DIN left and DIN right Suitability for fire protection doors Length - 239mm, Width - 32mm, Height - 45mm Closing force adjustable - 110-0 Latching action adjustable - 15-0 Back check integrated Finish: AN/BM	Pcs.		● Silver Anodized ● Black Matt

● Gold Matt ● Champagne Matt ● Rose Gold Matt
*Finishes Available on Request

HARDWARE ACCESSORIES



NY Glazing HARDWARE

IMAGES	CODE	DESCRIPTION	UNIT	SIZE	COLOUR
	NSK-ACC-780-PLATE STD SILVER NSK-ACC-780-PLATE STD BM	Mounting Plate for Scissor/Cross Arm Door Closer Material: Aluminium Finish : AN/BM	Pcs.		● Silver Anodized ● Black Matt
	OML-33A 35x85MM SSS OML-33A 35x85MM BM	Narrow Style Lock Body for Aluminium Doors with Latch & Dead Bolt Finish : SSS/BM	Pcs.		● Silver Anodized ● Black Matt
	OZML-DL1 30MM SSS OZML-DL1 30MM BM	Narrow Style Mortise Lock Body with Dead Bolt(Also Suitable for Aluminium Framed Doors) Finish : SSS	Pcs.		● SSS ● Black Matt
	OZML-DL1 35MM SSS OZML-DL1 35MM BM	Narrow Style Mortise Lock Body with Dead Bolt(Also Suitable for Aluminium Framed Doors) Finish : SSS	Pcs.		● SSS ● Black Matt
	OZADS-11C 830 OZADS-11C 930 OZADS-11C 1030	Dropdown seal 830/930/1030 (Cross-section dimension is 28X30mm)	Pcs.		
	OZADS-44G 1030 OZADS-44G 1130 OZADS-44G 1220	Glass dropdown seal	Pcs.		
	OZ-2BB-FP-SL 5"x3"x3MM SSS OZ-2BB-FP-SL 5"x3"x3MM BM	K-LITE flush hinges comes in SUS 304. Hinges comes in Stainless Steel finish. Weight : 50 Kgs / Pair Size : 120mm	Pcs.		● SSS ● Black Matt
	OZKLPH-001 STD AL OZKLPH-001 STD BK	K-LITE material consists of alloy material. Hinges comes in brush aluminium finish. For glass thickness : 10mm to 12mm Max. door weight : 50 Kgs / Pair Max. door width : 900mm Max. door height : 2700mm	Pcs.		● Silver Anodized ● Black Matt

● Gold Matt ● Champagne Matt ● Rose Gold Matt
*Finishes Available on Request

HARDWARE ACCESSORIES

NY Glazing HARDWARE

IMAGES	CODE	DESCRIPTION	UNIT	SIZE	COLOUR
	OZ-FDL-33 LIFE SW STD	Smart Feature: Suitable for both Sliding & Swing Door Passage Mode Anti-Theft Password Audit Trail Low Power Consumption Dual Combination Mode* Smart Freeze USB for Battery Backup Privacy Locking Password: 6 ~15 digits number combination Door Thickness: 35~80mm Power: AAA Alkaline battery X 4 (DC 6V) Battery Life: Approx. 3500 Open & Close Operations Types of Password : Timed Permanent One Time Access Modes: Fingerprint Upto 100 Nos. RFID Upto 100 Nos. Password Upto 100 Nos.	Pcs.		● Black Matt
	OZ-FDL-33 LIFE SL STD	Smart Feature: Suitable for both Sliding & Swing Door Passage Mode Anti-Theft Password Audit Trail Low Power Consumption Dual Combination Mode* Smart Freeze USB for Battery Backup Privacy Locking Password: 6 ~15 digits number combination Door Thickness: 35~80mm Power: AAA Alkaline battery X 4 (DC 6V) Battery Life: Approx. 3500 Open & Close Operations Types of Password : Timed Permanent One Time Access Modes: Fingerprint Upto 100 Nos. RFID Upto 100 Nos. Password Upto 100 Nos.	Pcs.		● Black Matt

SD 60-DOOR FRAMED PROFILE



SD 60

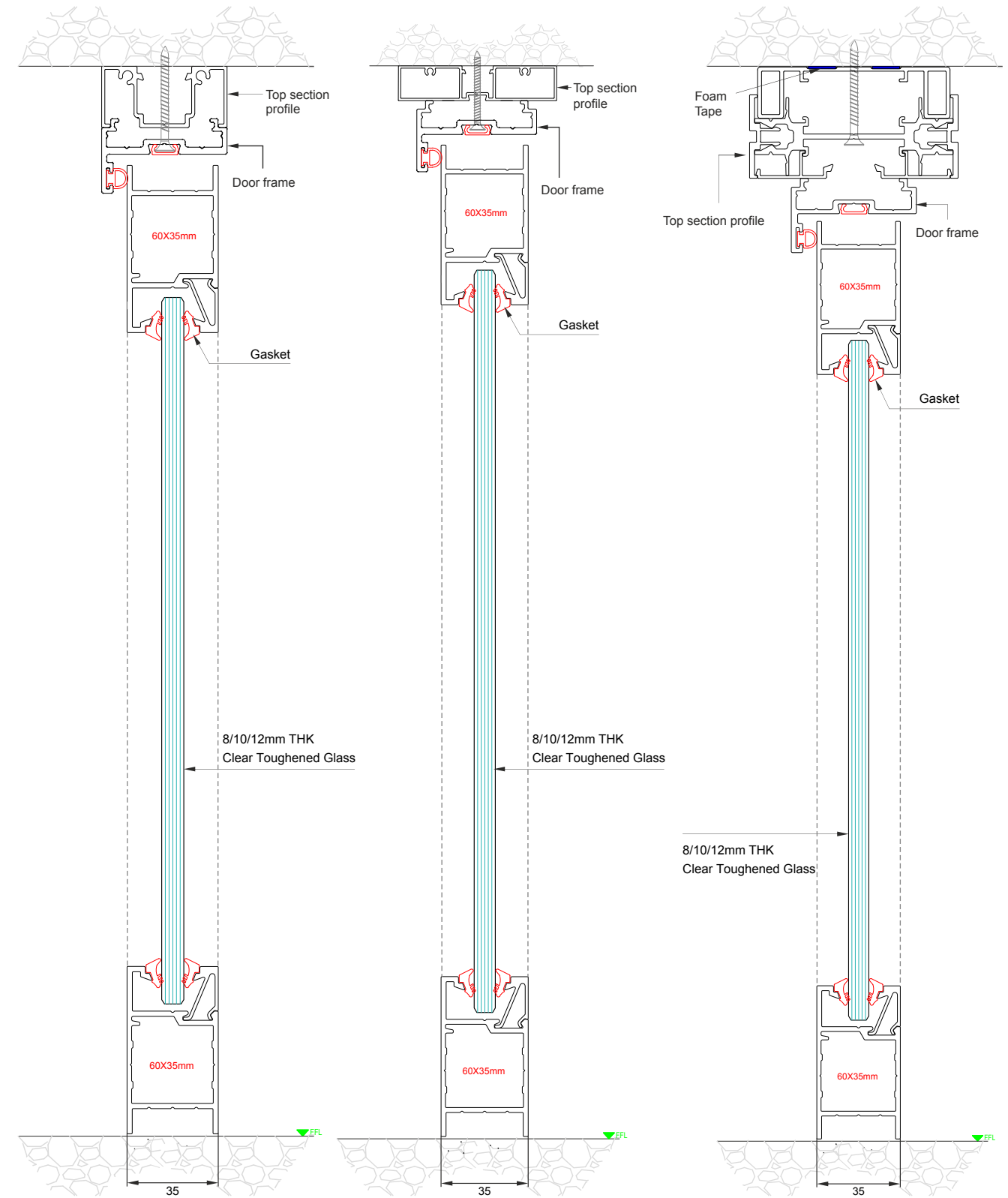

SD 75-DOOR FRAMED PROFILE



SD 75

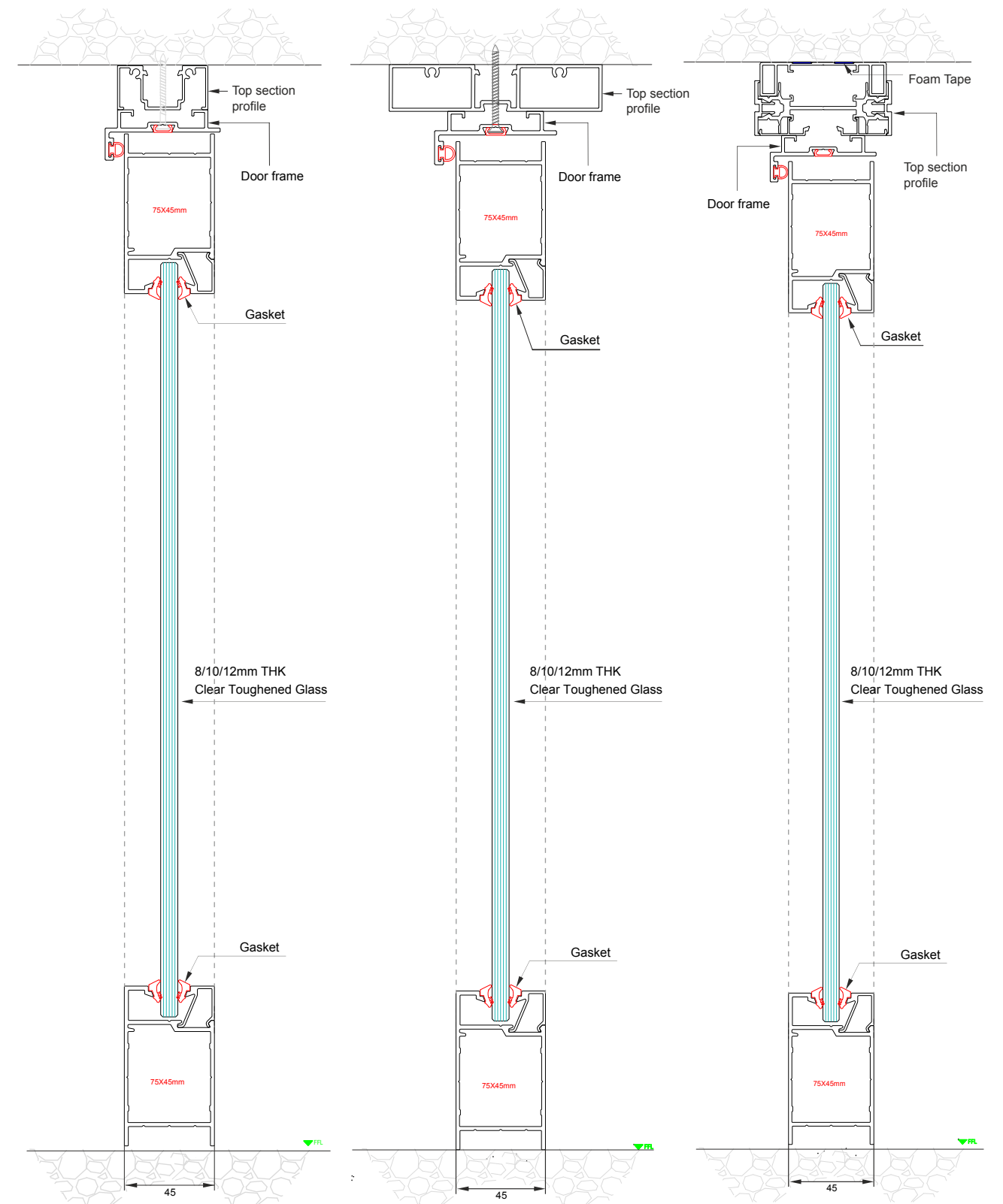

FRAMED SLIDING



FRAMED SLIDING

Technical Detail

Sliding door system enables glass doors to retain their minimalist aesthetics.

Sliding glass doors provide huge space benefit and minimalist design. When combined with proven roller technology, it ensures that even high doors can be operated smoothly and with ease.

The doors are gently decelerated and reliably hold in both their closed and opened states by specially developed catch type buffers.

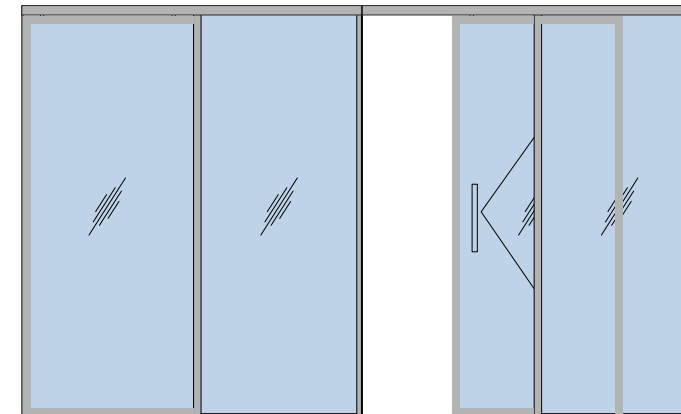
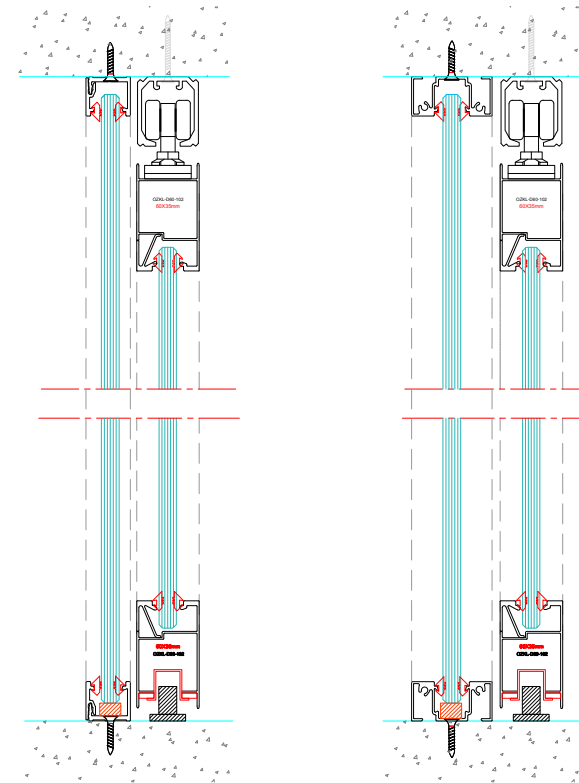

OZ-ESL-WD-44-SC-N STD
Soft Close Sliding System with
Accessories for Framed/Wooden Door
(Single Door) W/O Track
Maximum Door Weight: 60kg/Door



OZ-ESL-TRACK-E5-N 2M STD
OZ-ESL-TRACK-E5-N 4M STD
Top Track Available in 2mtr & 4mtr



OZ-ESL-FG-BT 2M STD
Bottom Track



OGH-55 32x457MM SSS
OGH-55 32x457MM BM
OGH-55 25x600MM SSS
OGH-55 25x600MM BM
For glass thickness : 10mm to 12mm
SSS/BM finish.
Material : SUS 304

GLASS DOOR



ACCESS CONTROL PANEL



ACCESS CONTROL PANEL

Single & Double Glazing

Primarily, K-LITE offers 3 types of Panels as standard design assembling, available with existing K-LITE Demountable Partition Series. Aparten required by the client.

Panels available are as follows:

- 45 x 50 series (Compact series)
- 80 x 80 series (Eta Portal)
- 100 x 100 series (Eco line Portal)

K-LITE Tech panels not only provide acoustic values, which strengthen the integrity of the room, but also conceal all power and data cables required for electrical switches/devices, embedded within the Tech panel face.

Ideally, room booking systems are mounted on an adjacent wall outside meeting room, which can be problematic. If the meeting room front is of glass construction, wiring and fixing cables cannot be kept open. With K-LITE Tech panels, things become easy since all cabling gets concealed within the cavity to meet the aesthetics and usability.

Meeting rooms are mostly occupied for multiple meetings and conference spaces. These K-LITE Tech panels provide the necessary tools for booking system. This piece of technology allows people to see if a meeting room is available or in use, as well as view the information in meeting scheduler about the meeting which is going to take place in that cabin.

Available with 2 finish : Anodised Aluminium and Matt Black, readily available at any given point off the shelf.

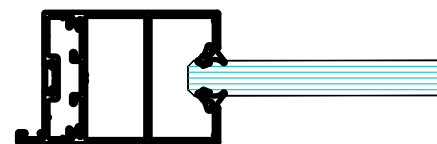

45 x 50 series (Compact series)

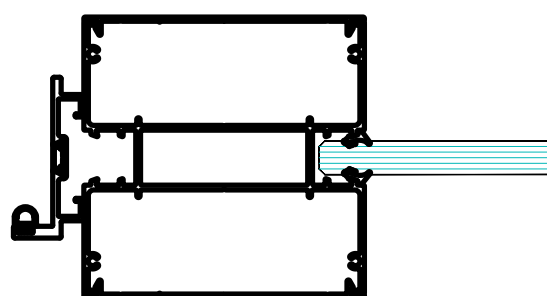

100x100 series (Eco line Portal)



HARDWARE

Sophisticated design and functional quality are the characteristics of K-LITE fittings. They excel in terms of both technology and operating reliability, manufactured from high grade materials which are carefully crafted.

K-LITE door hinges satisfies demands with respect to stability, safety and corrosion resistance.

OZKLPH-001 STD AL OZKLPH-001 STD BK Glass Door Hinges (Square)

K-LITE material consists of alloy material. Hinges comes in brush aluminium finish. For glass thickness : 10mm to 12mm
Max. door weight : 50 Kgs / Pair
Max. door width : 900mm
Max. door height : 2700mm

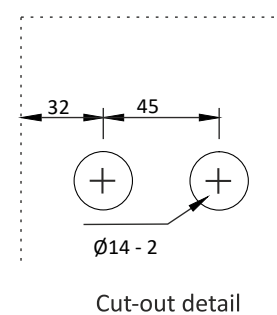
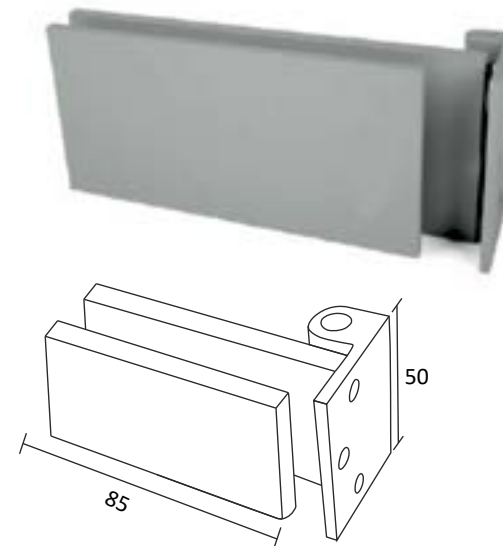

Available Finish: Black Silver

K-LITE pivot series reflect charm and neatness with their simple and minimal visibility, to enhance the inherent beauty and character for toughened frame less glass doors.

OZ-PGDH STD BM OZ-PGDH STD SSS Glass Door Pivot Hinges (Square)

K-LITE material consists of alloy material. Hinges comes in brush aluminium finish. For glass thickness : 10mm to 12mm
Max. door weight : 50 Kgs / Pair
Max. door width : 900mm
Max. door height : 2700mm

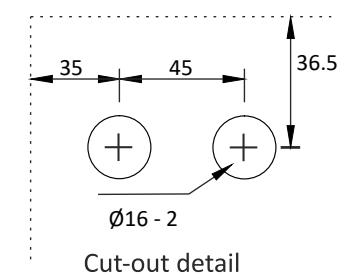
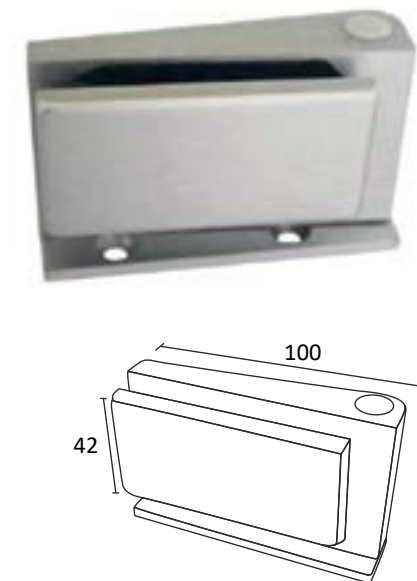

Available Finish: Black Silver

HARDWARE

From the inception, K-LITE has been devoted to developing new and innovative products in the tradition of the finest design and craftsmanship.

OZ-DP1/2-GDL STD AN
OZ-DP1/2-GDL STD BM
Glass Door Studio Lock

K-LITE material consists of Alloy material.
Hinges comes in Aluminium finish.
For glass thickness : 10mm to 12mm

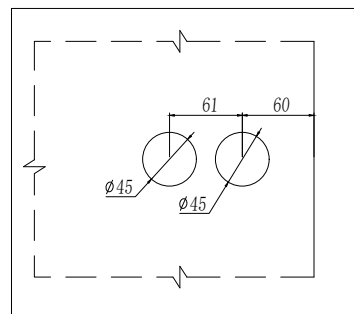

Available Finish:  
Black Silver

Security, being a prime concern, what would be better than a bottom patch lock which takes care of it elegantly. K-LITE not only have a regular bottom lock, but with aluminium finish to give it a neat look.

OPL-1P STD BM
OPL-1P STD SS
Glass Bottom Lock

K-LITE material consists of Alloy material.
Lock comes in Black finish & Stainless Steel finish.
For glass thickness : 10mm to 12mm

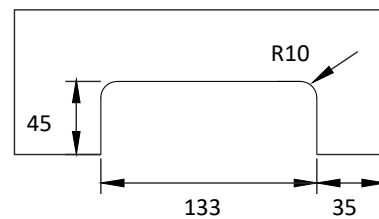
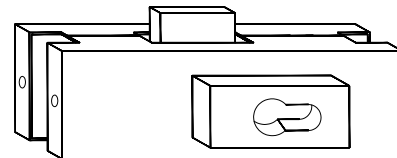

Cut-out detail

Available Finish:  
Black Silver

HARDWARE

Sophisticated design and functional quality are the characteristics of the K-LITE fittings. K-LITE hardware includes the most popular model, all of which are right or left spring, in order to return the lever handle to the horizontal position. K-LITE hardware is suitable for standard, national and international applications eg. commercial spaces, school, mall segment and interior doors in office buildings.

OMH-11LN STD SSS
Mortise Handle

K-LITE material consists of SUS 304.
Lever Handle in Stainless Steel finish.
Suitable for Aluminium Frame Doors & Flush Doors.
Available with oval shape rosettes.

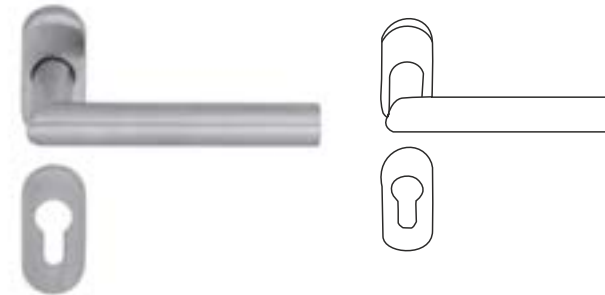

OMH-33N STD SSS
Mortise Handle

K-LITE material consists of SUS 304.
Lever Handle in Stainless Steel finish.
Suitable for Aluminium Frame Doors & Flush Doors.
Available with oval shape rosettes.

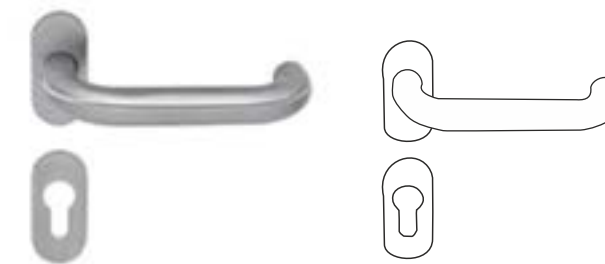

Available Finish:  
Black Silver

OZKCLKH - 001
Oval Key Hole

Material : SS SUS 304
Oval Key Hole Use For Dead Lock.

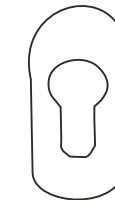

Available Finish:  
Black Silver

OMC-11-K2N-P 60/70/80MM SN
Cylinder

Material : SS SUS 304
Supplied with 5 keys computerised.
Size : 60mm/70mm.
One side Knob + One side Key.

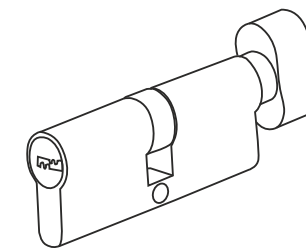

Available Finish:  
Black Silver

OZ-DST-11
Door Stopper

Ideal solution to stop door from going further more than required.
Half moon type door stopper.
Material : SUS 304

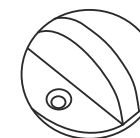

Available Finish:  
Black Silver

HARDWARE

They may not be apparent at first sight, but once noticed, it's visual impact is unmistakable. K-LITE handles enhance the allure of any door. Individual and versatile.

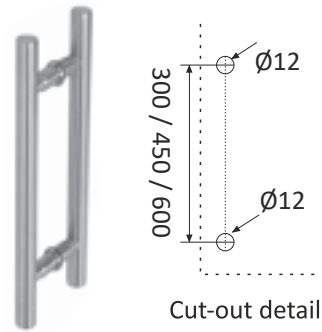

OGH-55 32X457MM SSS
OGH-55 25X600MM SSS
Glass Door Handle

K-LITE material consists of SUS 304 Material.
Hinges comes in Stainless Steel finish.
For glass thickness :10mm to 12mm
Size :300mm

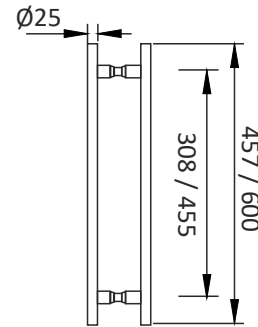

Available Finish:  
Black Silver

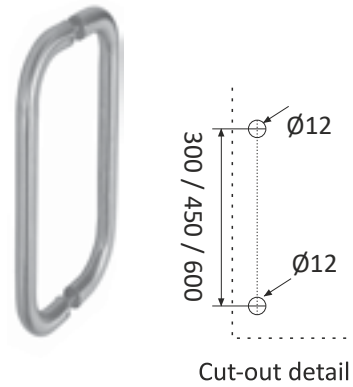

OGH-11 25X325MM SSS
OGH-11 25X450MM SSS
OGH-11 32X600MM SSS
Glass Door Handle

K-LITE material consists of SUS 304 Material.
Hinges comes in Stainless Steel finish.
For glass thickness :10mm to 12mm
Size :300mm

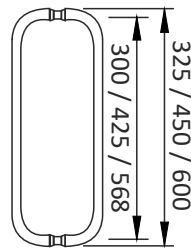

Available Finish:  
Black Silver

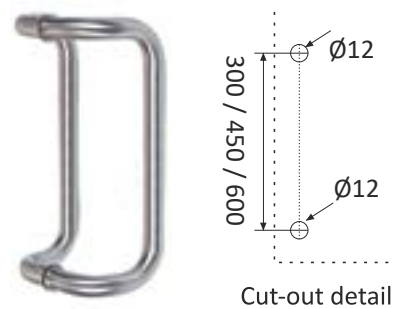

OGH-OFS-11 25X325MM SSS
OGH-OFS-11 25X475MM SSS
OGH-OFS-11 25X625MM SSS
Glass Door Handle

K-LITE material consists of SUS 304 Material.
Hinges comes in Stainless Steel finish.
For glass thickness :10mm to 12mm
Size :300mm

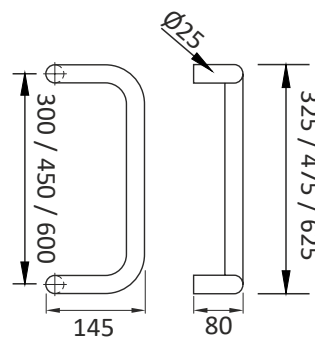

Available Finish:  
Black Silver

HARDWARE

K-LITE solid door hinges are superb in quality due to its latest mechanism and corrosion proof metal with SUS 304 grade quality. It's design gives an extra edge against regular fittings.

OZ-2BB-FP-SL 5"x3"x3MM BM
OZ-2BB-FP-SL 5"X3"X3MM SSS
Flush Hinges

K-LITE flush hinges comes in SUS 304.
Hinges comes in Stainless Steel finish.
Weight : 50 Kgs / Pair
Size : 120mm

Note : Color option available as required.

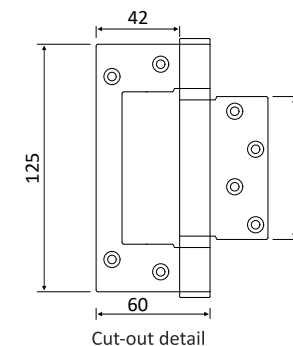
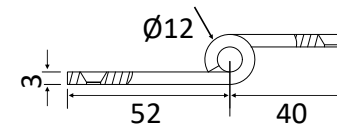

Available Finish:  
Black Silver

HARDWARE

K-LITE solid door hinges are superb in quality due to its latest mechanism and corrosion proof metal with SUS 304 grade quality. It's design gives an extra edge against regular fittings.

OML-33A 35X85MM SSS
OML-33A 30X85MM SSS
Mortise Lock Body

K-LITE Mortise Body comes in SS Material.
Suitable for Aluminium Frame Doors & Flush Doors.
Door Thickness : 35mm to 50mm

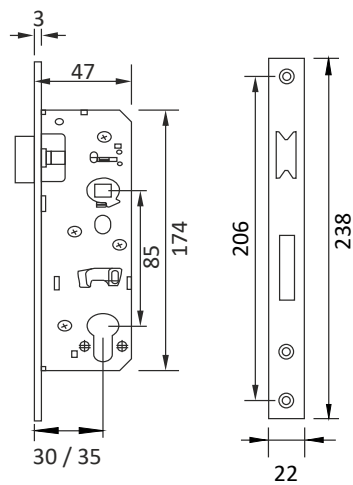

Available Finish:  
Black Silver

OZML-DL1 30MM SSS/BM
OZML-DL1 35MM SSS/BM
Dead Lock Body

K-LITE LITE Dead Body comes in SS Material.
Suitable for Aluminium Frame Doors & Flush Doors.
Door Thickness : 35mm to 50mm

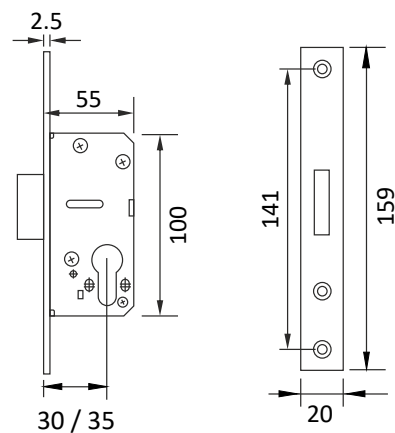

Available Finish:  
Black Silver

HARDWARE

NSK-ACC-980-PLATE STD SILVER
NSK-ACC-780-PLATE STD SILVER
Overhead Door Closer Glass Clamp

Overhead door closer glass clamp is used along with sliding arm door closer.

Material : Aluminium
Glass Thickness : 10mm to 12mm
Finish : Silver / Black

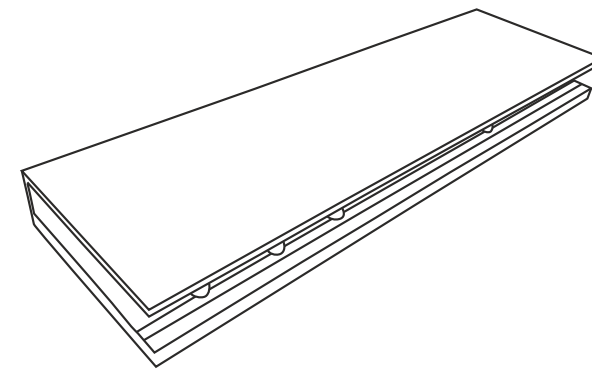

OZKLAP - 01
Specially designed Amateur Plate

Used between door closer & glass clamp to fill the gap.

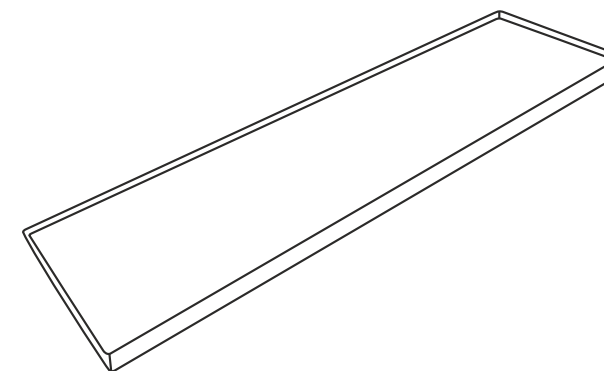

K-LITE

Demountable
Partitioning
Systems

NYGLAZING GROUP

29 Briarcliff Rd, Bergenfield NJ 07621

www.nyglazing.com | Phone: 1-855-694-5294 | Email: info@nyglazing.com